

PRODUCT FEATURES

- IGBT CHIP(Trench+Field Stop technology)
- Low saturation voltage and positive temperature coefficient
- Fast switching and short tail current
- Free wheeling diodes with fast and soft reverse recovery
- Temperature sense included

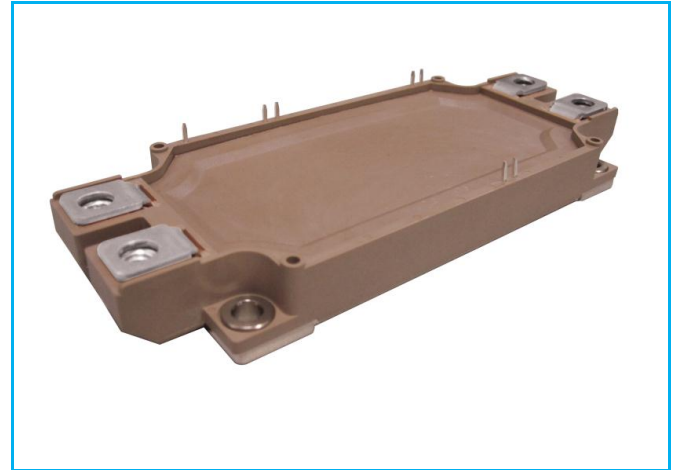

APPLICATIONS

- AC motor control
- Motion/servo control
- Inverter and power supplies
- Photovoltaic/Fuel cell

IGBT-inverter

ABSOLUTE MAXIMUM RATINGS($T_C=25^{\circ}\text{C}$ unless otherwise specified)

Symbol	Parameter/Test Conditions	Values	Unit
V_{CES}	Collector Emitter Voltage	$T_J=25^{\circ}\text{C}$	1200
V_{GES}	Gate Emitter Voltage		± 20
I_C	DC Collector Current	$T_C=25^{\circ}\text{C}, T_{Jmax}=175^{\circ}\text{C}$	660
		$T_C=95^{\circ}\text{C}, T_{Jmax}=175^{\circ}\text{C}$	450
I_{CM}	Repetitive Peak Collector Current	$t_p=1\text{ms}$	900
P_{tot}	Power Dissipation Per IGBT	$T_C=25^{\circ}\text{C}, T_{Jmax}=175^{\circ}\text{C}$	2305

Diode-inverter

ABSOLUTE MAXIMUM RATINGS ($T_C=25^{\circ}\text{C}$ unless otherwise specified)

Symbol	Parameter/Test Conditions	Values	Unit
V_{RRM}	Repetitive Reverse Voltage	$T_J=25^{\circ}\text{C}$	1200
$I_{F(AV)}$	Average Forward Current		450
I_{FRM}	Repetitive Peak Forward Current	$t_p=1\text{ms}$	900
I^2t		$T_J=150^{\circ}\text{C}, t=10\text{ms}, V_R=0\text{V}$	31250

MacMic Science & Technology Co., Ltd.

Add: #18, Hua Shan Zhong Lu, New District, Changzhou City, Jiangsu Province, P. R. of China

Tel.: +86-519-85163708 Fax: +86-519-85162291 Post Code: 213022 Website: www.macmicst.com

MMG450WB120B6TC

IGBT-inverter

ELECTRICAL CHARACTERISTICS ($T_C=25^\circ\text{C}$ unless otherwise specified)

Symbol	Parameter/Test Conditions		Min.	Typ.	Max.	Unit	
$V_{GE(th)}$	Gate Emitter Threshold Voltage	$V_{CE}=V_{GE}, I_C=18\text{mA}$	5.0	5.8	6.5	V	
$V_{CE(sat)}$	Collector Emitter Saturation Voltage	$I_C=450\text{A}, V_{GE}=15\text{V}, T_J=25^\circ\text{C}$		1.85	2.25		
		$I_C=450\text{A}, V_{GE}=15\text{V}, T_J=125^\circ\text{C}$		2.15			
		$I_C=450\text{A}, V_{GE}=15\text{V}, T_J=150^\circ\text{C}$		2.2			
I_{CES}	Collector Leakage Current	$V_{CE}=1200\text{V}, V_{GE}=0\text{V}, T_J=25^\circ\text{C}$			1	mA	
		$V_{CE}=1200\text{V}, V_{GE}=0\text{V}, T_J=150^\circ\text{C}$			10		
I_{GES}	Gate Leakage Current	$V_{CE}=0\text{V}, V_{GE}=\pm 20\text{V}, T_J=25^\circ\text{C}$	-400		400	nA	
R_{Gint}	Integrated Gate Resistor			1.2		Ω	
Q_G	Gate Charge	$V_{CE}=600\text{V}, I_C=450\text{A}, V_{GE}=15\text{V}$		2.3		μC	
C_{ies}	Input Capacitance	$V_{CE}=25\text{V}, V_{GE}=0\text{V}, f=1\text{MHz}$		33		nF	
C_{res}	Reverse Transfer Capacitance				1.7		nF
$t_{d(on)}$	Turn on Delay Time	$V_{CC}=600\text{V}, I_C=450\text{A}$ $R_G=1.5\Omega,$ $V_{GE}=\pm 15\text{V},$ Inductive Load	$T_J=25^\circ\text{C}$		120		ns
			$T_J=150^\circ\text{C}$		150		ns
t_r	Rise Time	$V_{GE}=\pm 15\text{V},$ Inductive Load	$T_J=25^\circ\text{C}$		80		ns
			$T_J=150^\circ\text{C}$		90		ns
$t_{d(off)}$	Turn off Delay Time	$V_{CC}=600\text{V}, I_C=450\text{A}$ $R_G=1.5\Omega,$ $V_{GE}=\pm 15\text{V},$ Inductive Load	$T_J=25^\circ\text{C}$		510		ns
			$T_J=150^\circ\text{C}$		580		ns
t_f	Fall Time	$V_{GE}=\pm 15\text{V},$ Inductive Load	$T_J=25^\circ\text{C}$		90		ns
			$T_J=150^\circ\text{C}$		200		ns
E_{on}	Turn on Energy	$V_{CC}=600\text{V}, I_C=450\text{A}$ $R_G=1.5\Omega,$ $V_{GE}=\pm 15\text{V},$ Inductive Load	$T_J=25^\circ\text{C}$		38		mJ
			$T_J=125^\circ\text{C}$		57.5		mJ
			$T_J=150^\circ\text{C}$		62.5		mJ
E_{off}	Turn off Energy	$V_{GE}=\pm 15\text{V},$ Inductive Load	$T_J=25^\circ\text{C}$		33		mJ
			$T_J=125^\circ\text{C}$		45		mJ
			$T_J=150^\circ\text{C}$		48.5		mJ
I_{SC}	Short Circuit Current	$tpsc \leq 10\mu\text{s}, V_{GE}=15\text{V}$ $T_J=150^\circ\text{C}, V_{CC}=800\text{V}$		1500		A	
R_{thJC}	Junction to Case Thermal Resistance (Per IGBT)				0.065	K /W	

Diode-inverter

ELECTRICAL CHARACTERISTICS ($T_C=25^\circ\text{C}$ unless otherwise specified)

Symbol	Parameter/Test Conditions		Min.	Typ.	Max.	Unit
V_F	Forward Voltage	$I_F=450\text{A}, V_{GE}=0\text{V}, T_J=25^\circ\text{C}$		1.8	2.3	V
		$I_F=450\text{A}, V_{GE}=0\text{V}, T_J=125^\circ\text{C}$		1.65		
		$I_F=450\text{A}, V_{GE}=0\text{V}, T_J=150^\circ\text{C}$		1.65		
t_{rr}	Reverse Recovery Time	$I_F=450\text{A}, V_R=600\text{V}$ $di_F/dt=-4700\text{A}/\mu\text{s}$ $T_J=150^\circ\text{C}$		500		ns
I_{RRM}	Max. Reverse Recovery Current			360		A
Q_{RR}	Reverse Recovery Charge			83.5		μC
E_{rec}	Reverse Recovery Energy			31		mJ
R_{thJCD}	Junction to Case Thermal Resistance (Per Diode)				0.1	K /W

MMG450WB120B6TC

NTC CHARACTERISTICS ($T_C=25^\circ\text{C}$ unless otherwise specified)

Symbol	Parameter/Test Conditions	Min.	Typ.	Max.	Unit
R_{25}	Resistance $T_C=25^\circ\text{C}$		5		k Ω
$B_{25/50}$	$R_2 = R_{25} \exp [B_{25/50}(1/T_2 - 1/(298.15 \text{ K}))]$		3375		K

MODULE CHARACTERISTICS ($T_C=25^\circ\text{C}$ unless otherwise specified)

Symbol	Parameter/Test Conditions	Values	Unit	
T_{Jmax}	Max. Junction Temperature	175	°C	
T_{Jop}	Operating Temperature	-40~150		
T_{stg}	Storage Temperature	-40~125		
V_{isol}	Isolation Breakdown Voltage	AC, 50Hz(R.M.S), t=1minute	3000	V
CTI	Comparative Tracking Index		> 225	
Torque	to heatsink	Recommended (M5)	2.5~5	Nm
	to terminal	Recommended (M6)	3~5	Nm
Weight			350	g

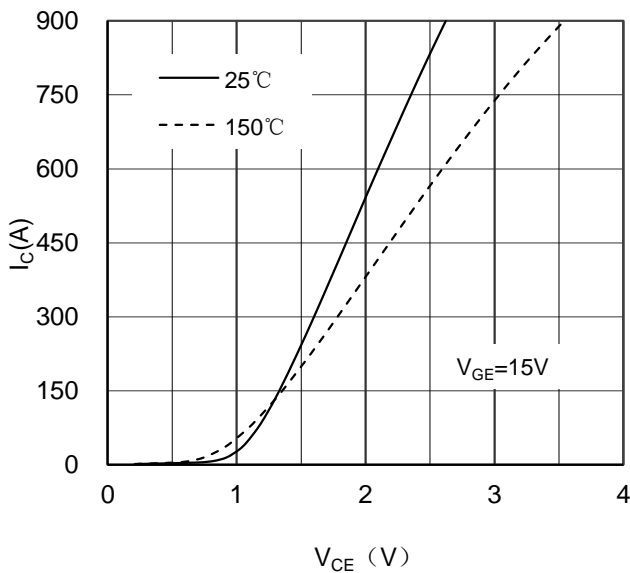

Figure 1. Typical Output Characteristics IGBT-inverter

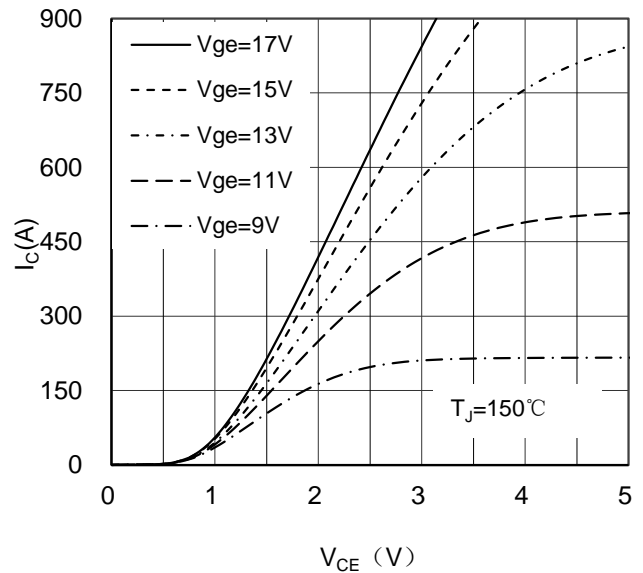

Figure 2. Typical Output Characteristics IGBT-inverter

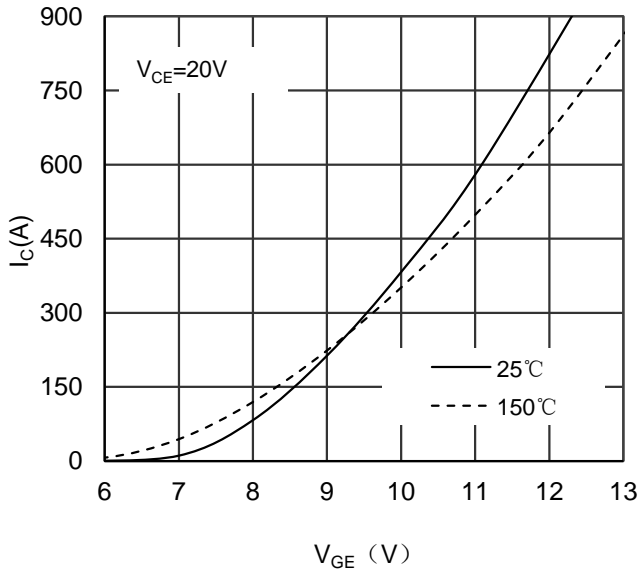

Figure 3. Typical Transfer characteristics IGBT-inverter

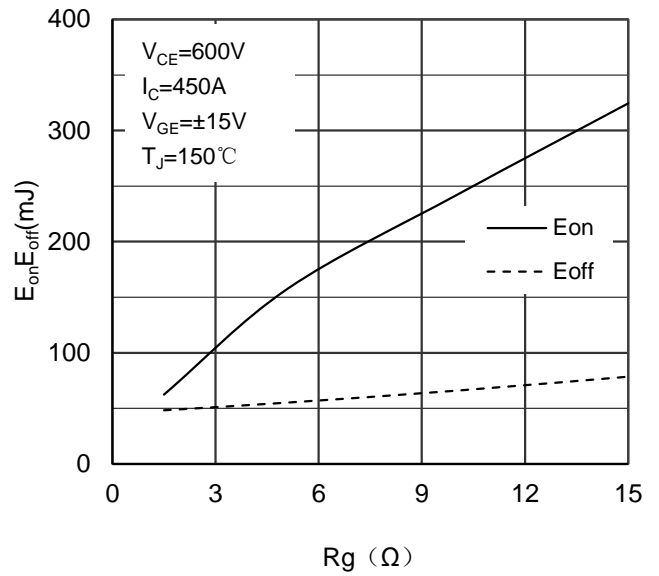

Figure 4. Switching Energy vs Gate Resistor IGBT-inverter

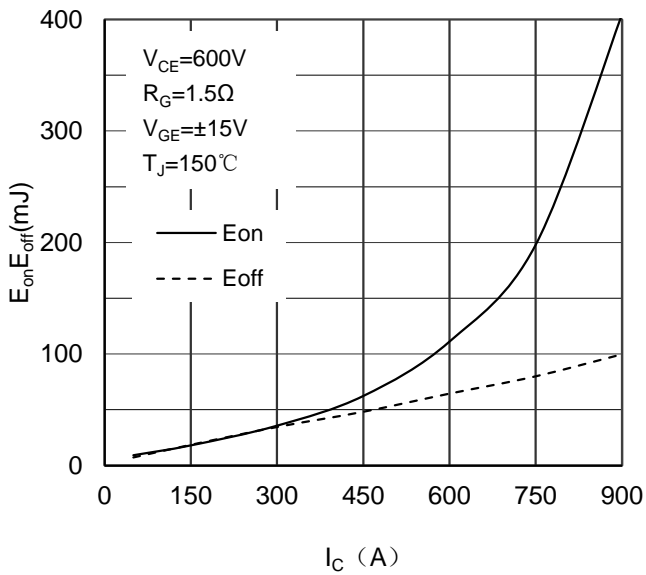

Figure 5. Switching Energy vs Collector Current IGBT-inverter

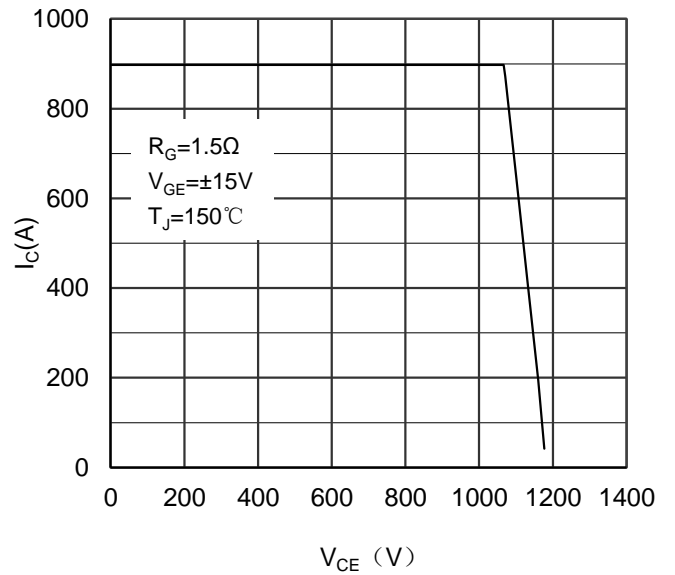

Figure 6. Reverse Biased Safe Operating Area IGBT-inverter

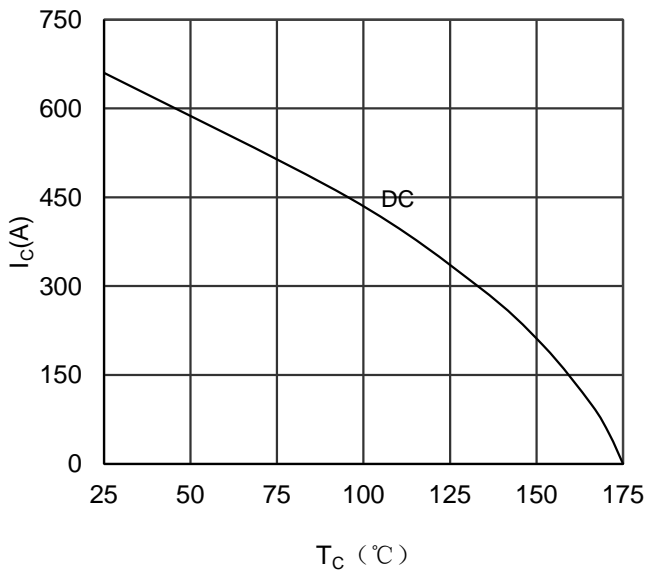

Figure 7. Collector Current vs Case temperature IGBT-inverter

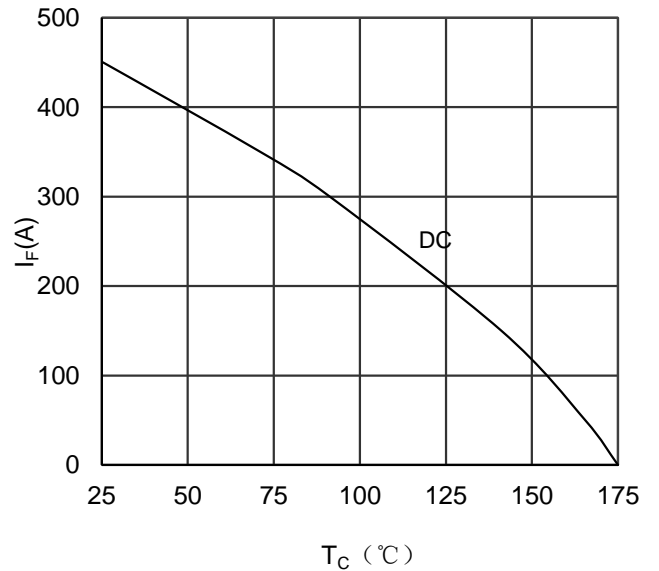

Figure 8. Forward current vs Case temperature Diode-inverter

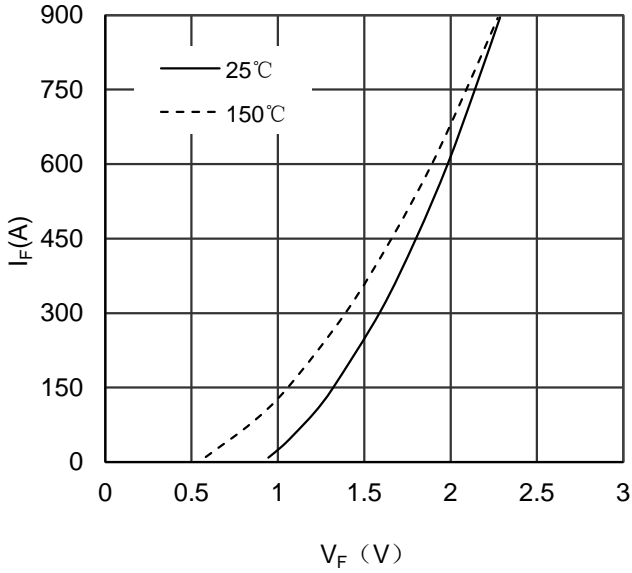

Figure 9. Diode Forward Characteristics Diode -inverter

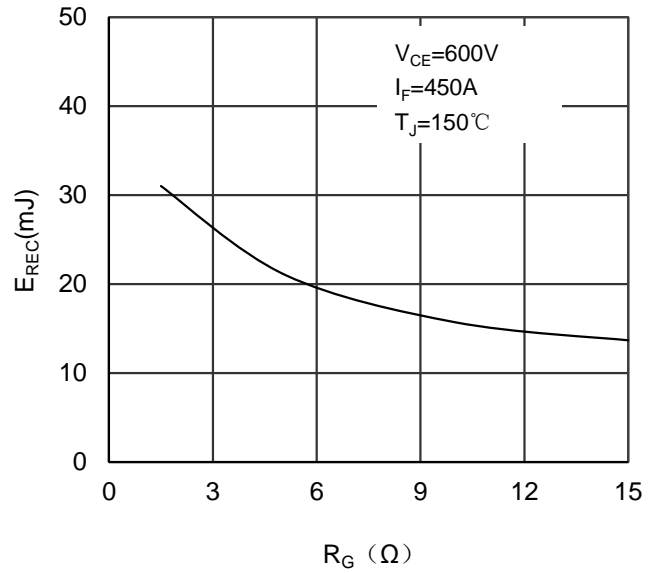

Figure 10. Switching Energy vs Gate Resistor Diode -inverter

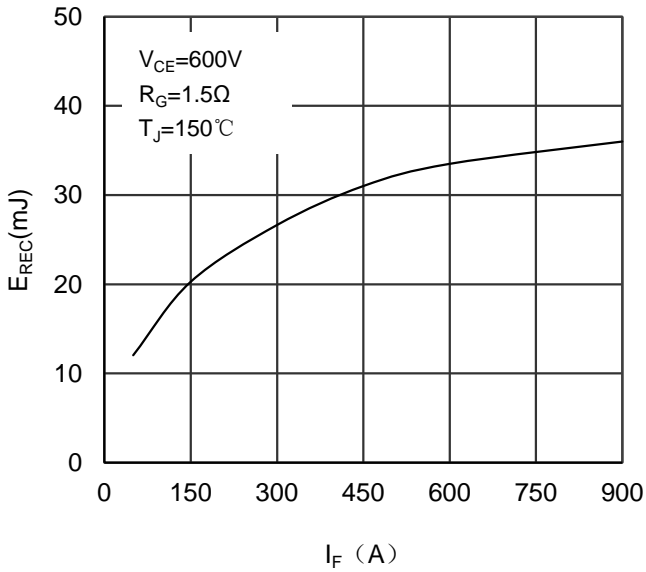

Figure 11. Switching Energy vs Forward Current Diode-inverter

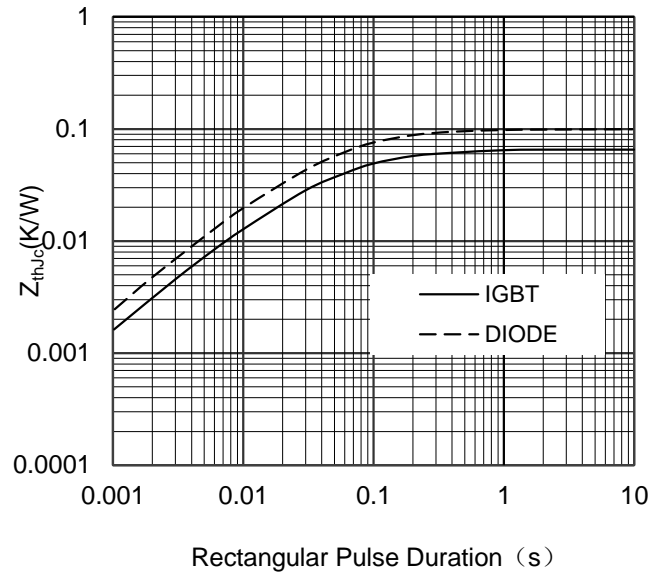

Figure 12. Transient Thermal Impedance of Diode and IGBT-inverter

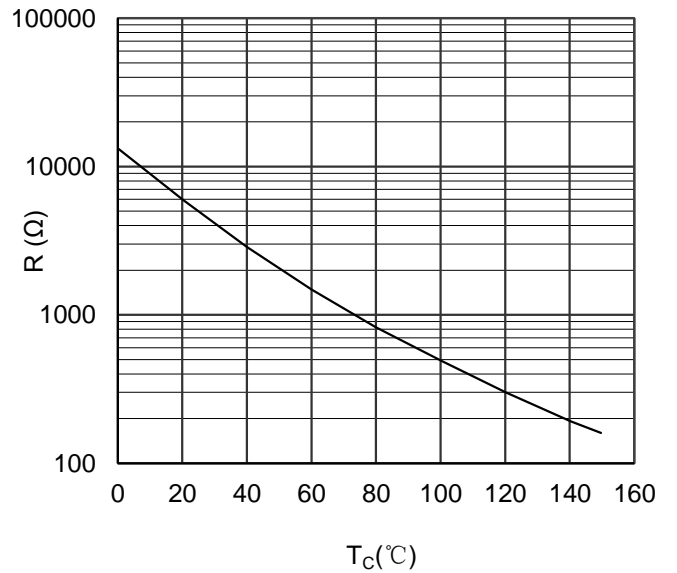

Figure 13. NTC Characteristics

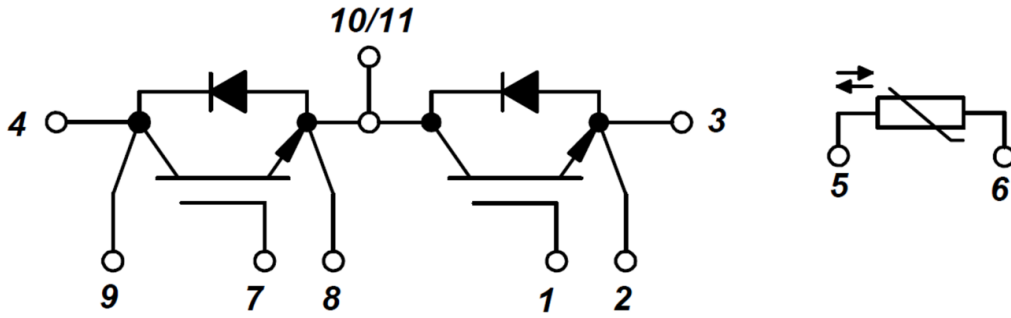
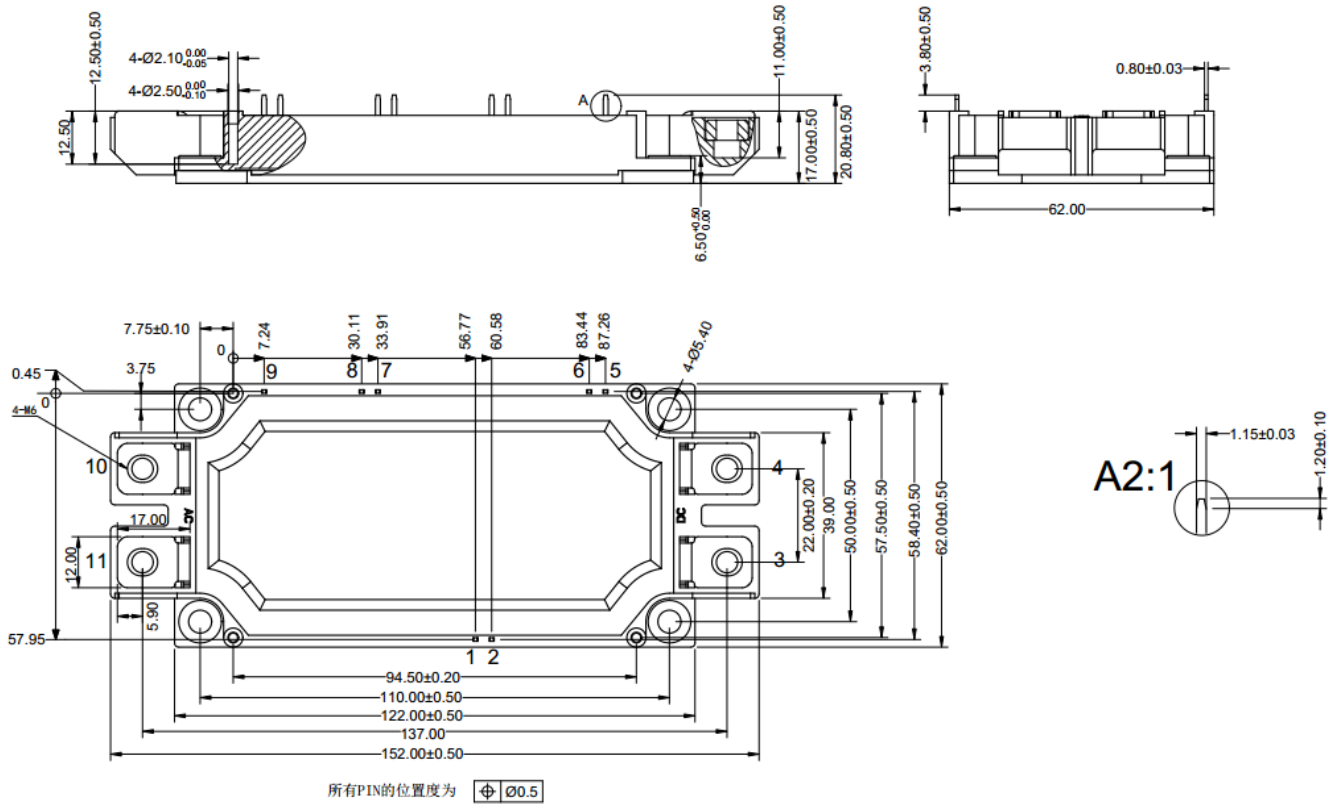

Figure 14. Circuit Diagram



Dimensions in (mm)
Figure 15. Package Outline