

## PRODUCT FEATURES

- IGBT CHIP(1700V Trench+Field Stop technology)
- Low turn-off losses, short tail current
- $V_{CE(sat)}$  with positive temperature coefficient
- Ultra Low Loss,High Ruggedness
- Free wheeling diodes with fast and soft reverse recovery



## APPLICATIONS

- AC motor control
- Motion/servo control
- Inverter and power supplies
- Photovoltaic/Fuel cell

### IGBT-inverter

ABSOLUTE MAXIMUM RATINGS( $T_C=25^{\circ}\text{C}$  unless otherwise specified)

Symbol	Parameter/Test Conditions		Values	Unit
$V_{CES}$	Collector Emitter Voltage	$T_J=25^{\circ}\text{C}$	1700	V
$V_{GES}$	Gate Emitter Voltage		$\pm 20$	
$I_C$	DC Collector Current	$T_C=25^{\circ}\text{C}, T_{Jmax}=175^{\circ}\text{C}$	230	A
		$T_C=100^{\circ}\text{C}, T_{Jmax}=175^{\circ}\text{C}$	150	
$I_{CM}$	Repetitive Peak Collector Current	$t_p=1\text{ms}$	300	
$P_{tot}$	Power Dissipation Per IGBT	$T_C=25^{\circ}\text{C}, T_{Jmax}=175^{\circ}\text{C}$	1071	W

### Diode-inverter

ABSOLUTE MAXIMUM RATINGS ( $T_C=25^{\circ}\text{C}$  unless otherwise specified)

Symbol	Parameter/Test Conditions		Values	Unit
$V_{RRM}$	Repetitive Reverse Voltage	$T_J=25^{\circ}\text{C}$	1700	V
$I_{F(AV)}$	Average Forward Current		150	A
$I_{FRM}$	Repetitive Peak Forward Current	$t_p=1\text{ms}$	300	
$I^2t$		$T_J=125^{\circ}\text{C}, t=10\text{ms}, V_R=0\text{V}$	4200	$\text{A}^2\text{S}$

MacMic Science & Technology Co., Ltd.

Add: #18, Hua Shan Zhong Lu, New District, Changzhou City, Jiangsu Province, P. R. of China

# MMG150D170B6TC

## IGBT-inverter

### ELECTRICAL CHARACTERISTICS ( $T_C=25^\circ\text{C}$ unless otherwise specified)

Symbol	Parameter/Test Conditions		Min.	Typ.	Max.	Unit
$V_{GE(th)}$	Gate Emitter Threshold Voltage	$V_{CE}=V_{GE}, I_C=6\text{mA}$	5.0	5.8	6.5	V
$V_{CE(sat)}$	Collector Emitter Saturation Voltage	$I_C=150\text{A}, V_{GE}=15\text{V}, T_J=25^\circ\text{C}$		2.15	2.6	
		$I_C=150\text{A}, V_{GE}=15\text{V}, T_J=125^\circ\text{C}$		2.35		
		$I_C=150\text{A}, V_{GE}=15\text{V}, T_J=150^\circ\text{C}$		2.45		
$I_{CES}$	Collector Leakage Current	$V_{CE}=1700\text{V}, V_{GE}=0\text{V}, T_J=25^\circ\text{C}$			1	mA
		$V_{CE}=1700\text{V}, V_{GE}=0\text{V}, T_J=150^\circ\text{C}$			10	mA
$I_{GES}$	Gate Leakage Current	$V_{CE}=0\text{V}, V_{GE}=\pm 15\text{V}, T_J=25^\circ\text{C}$	-500		500	nA
$R_{gint}$	Integrated Gate Resistor			3.5		$\Omega$
$Q_g$	Gate Charge	$V_{CE}=900\text{V}, I_C=150\text{A}, V_{GE}=15\text{V}$		1.1		$\mu\text{C}$
$C_{ies}$	Input Capacitance	$V_{CE}=25\text{V}, V_{GE}=0\text{V}, f=1\text{MHz}$		14.2		nF
$C_{res}$	Reverse Transfer Capacitance				450	
$t_{d(on)}$	Turn on Delay Time	$V_{CC}=900\text{V}, I_C=150\text{A}$ $R_G=3.6\Omega,$ $V_{GE}=\pm 15\text{V},$ Inductive Load	$T_J=25^\circ\text{C}$		130	ns
			$T_J=150^\circ\text{C}$		160	ns
$t_r$	Rise Time	$V_{GE}=\pm 15\text{V},$ Inductive Load	$T_J=25^\circ\text{C}$		65	ns
			$T_J=150^\circ\text{C}$		70	ns
$t_{d(off)}$	Turn off Delay Time	$V_{CC}=900\text{V}, I_C=150\text{A}$ $R_G=3.6\Omega,$ $V_{GE}=\pm 15\text{V},$ Inductive Load	$T_J=25^\circ\text{C}$		500	ns
			$T_J=150^\circ\text{C}$		560	ns
$t_f$	Fall Time	$V_{GE}=\pm 15\text{V},$ Inductive Load	$T_J=25^\circ\text{C}$		200	ns
			$T_J=150^\circ\text{C}$		360	ns
$E_{on}$	Turn on Energy	$V_{CC}=900\text{V}, I_C=150\text{A}$ $R_G=3.6\Omega,$ $V_{GE}=\pm 15\text{V},$ Inductive Load	$T_J=25^\circ\text{C}$		60	mJ
			$T_J=125^\circ\text{C}$		72	mJ
			$T_J=150^\circ\text{C}$		76.5	mJ
$E_{off}$	Turn off Energy	$V_{GE}=\pm 15\text{V},$ Inductive Load	$T_J=25^\circ\text{C}$		23.5	mJ
			$T_J=125^\circ\text{C}$		34	mJ
			$T_J=150^\circ\text{C}$		37	mJ
$I_{SC}$	Short Circuit Current	$tpsc \leq 10\mu\text{s}, V_{GE}=15\text{V}$ $T_J=150^\circ\text{C}, V_{CC}=900\text{V}$		720		A
$R_{thJC}$	Junction to Case Thermal Resistance ( Per IGBT )				0.14	K/W

## Diode-inverter

### ELECTRICAL CHARACTERISTICS ( $T_C=25^\circ\text{C}$ unless otherwise specified)

Symbol	Parameter/Test Conditions		Min.	Typ.	Max.	Unit
$V_F$	Forward Voltage	$I_F=150\text{A}, V_{GE}=0\text{V}, T_J=25^\circ\text{C}$		1.8	2.2	V
		$I_F=150\text{A}, V_{GE}=0\text{V}, T_J=125^\circ\text{C}$		1.9		
		$I_F=150\text{A}, V_{GE}=0\text{V}, T_J=150^\circ\text{C}$		1.9		
$t_{rr}$	Reverse Recovery Time	$I_F=150\text{A}, V_R=900\text{V}$ $di_F/dt=-2100\text{A}/\mu\text{s}$ $T_J=150^\circ\text{C}$		850		ns
$I_{RRM}$	Max. Reverse Recovery Current			155		A
$Q_{RR}$	Reverse Recovery Charge			80		$\mu\text{C}$
$E_{rec}$	Reverse Recovery Energy			43		mJ
$R_{thJCD}$	Junction to Case Thermal Resistance ( Per Diode )				0.24	K/W

# MMG150D170B6TC

## MODULE CHARACTERISTICS ( $T_C=25^\circ\text{C}$ unless otherwise specified)

Symbol	Parameter/Test Conditions		Values	Unit
$T_{Jmax}$	Max. Junction Temperature		175	$^\circ\text{C}$
$T_{Jop}$	Operating Temperature		-40~150	
$T_{stg}$	Storage Temperature		-40~125	
$V_{isol}$	Isolation Breakdown Voltage	AC, 50Hz(R.M.S), t=1minute	4000	V
CTI	Comparative Tracking Index		> 225	
Torque	to heatsink	Recommended (M6)	3~5	Nm
	to terminal	Recommended (M6)	2.5~5	Nm
Weight			300	g

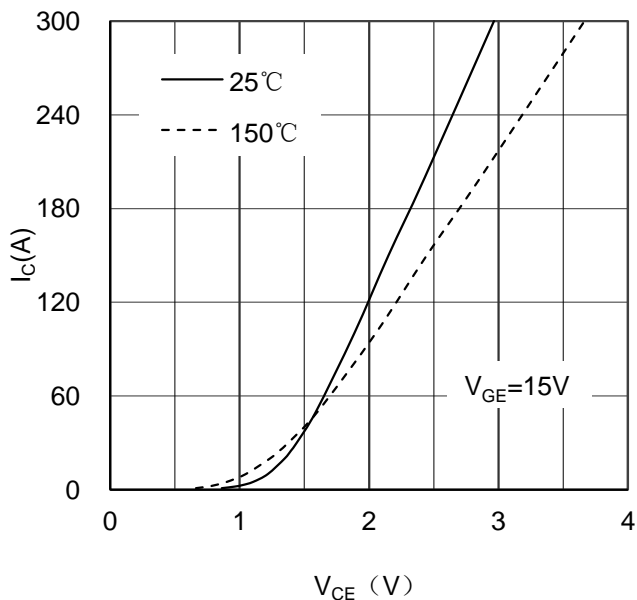

Figure 1. Typical Output Characteristics IGBT-inverter

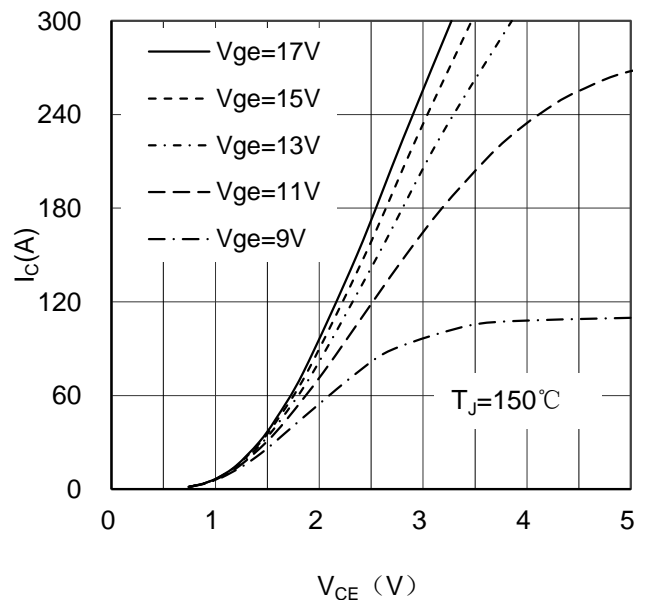

Figure 2. Typical Output Characteristics IGBT-inverter

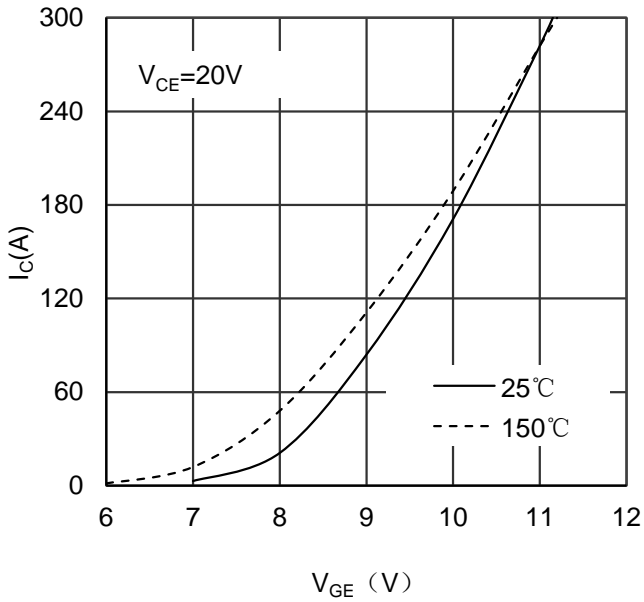

Figure 3. Typical Transfer characteristics IGBT-inverter

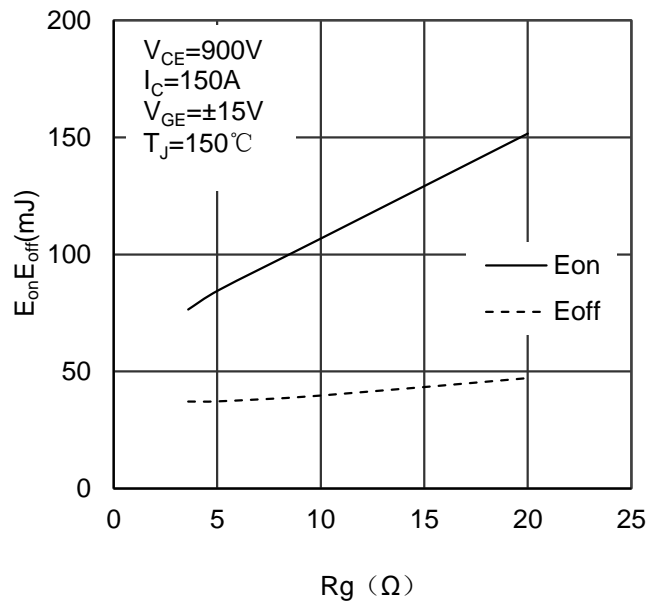

Figure 4. Switching Energy vs Gate Resistor IGBT-inverter

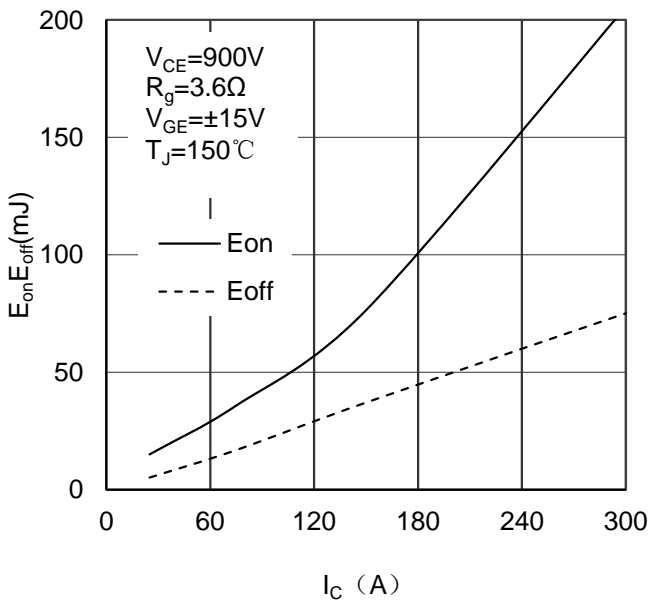

Figure 5. Switching Energy vs Collector Current IGBT-inverter

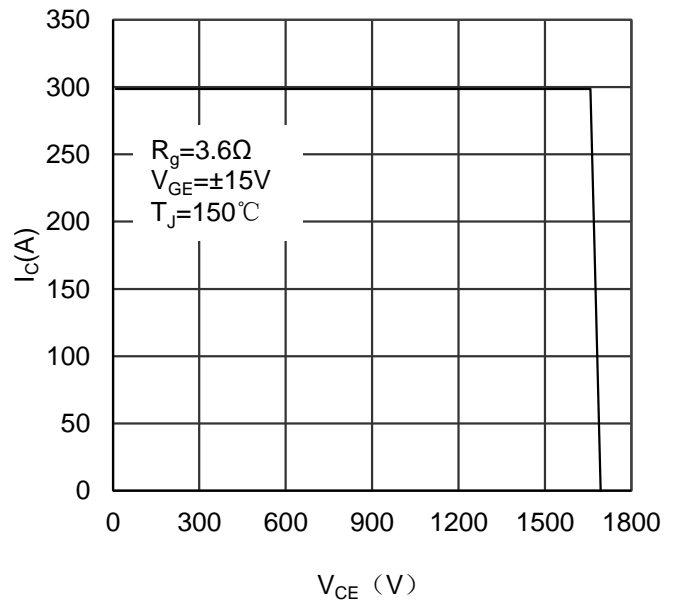

Figure 6. Reverse Biased Safe Operating Area IGBT-inverter

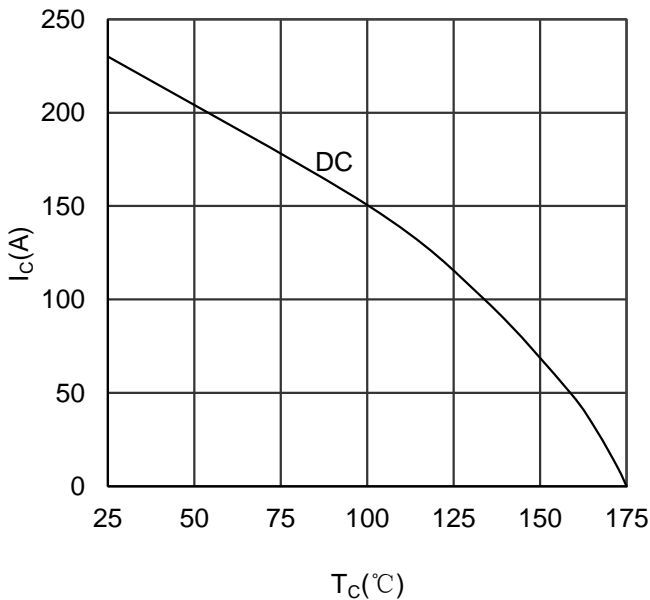

Figure 7. Collector Current vs Case temperature IGBT-inverter

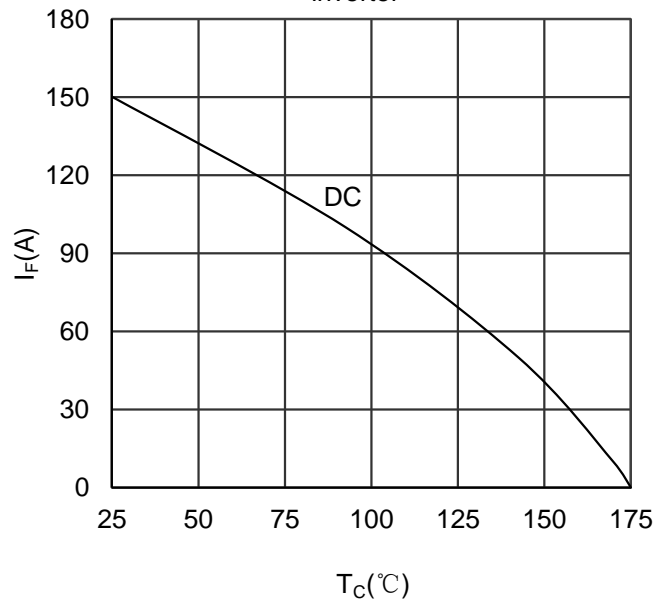

Figure 8. Forward current vs Case temperature Diode-inverter

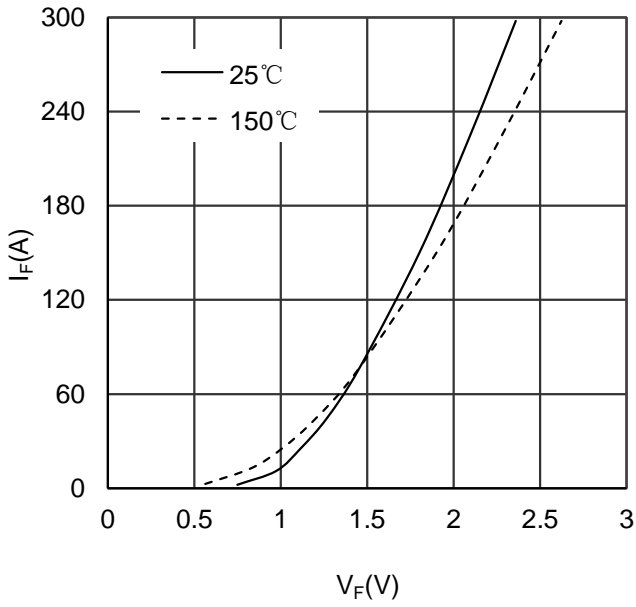

Figure 9. Diode Forward Characteristics Diode -inverter

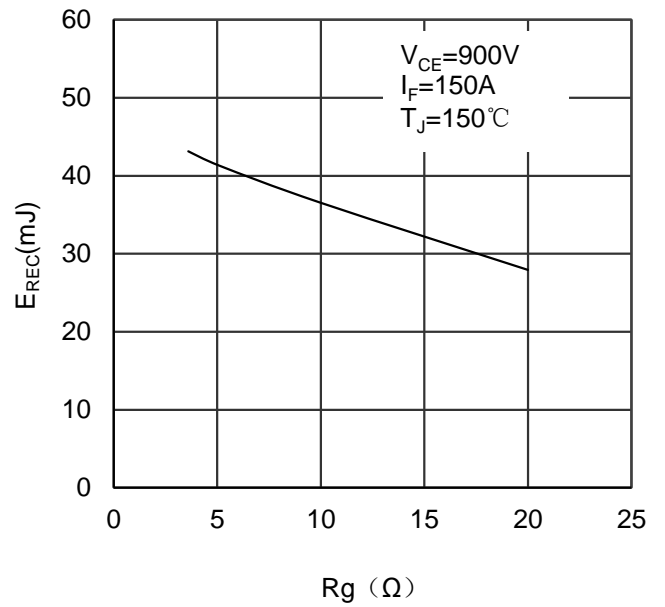

Figure 10. Switching Energy vs Gate Resistor Diode - inverter

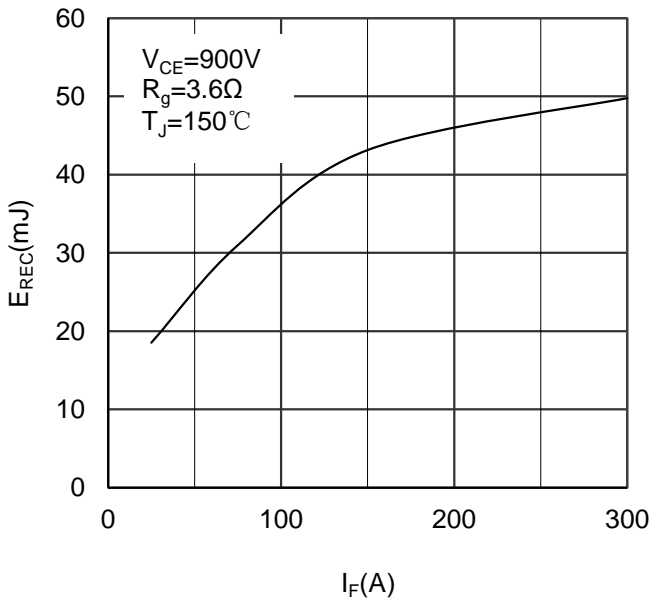

Figure 11. Switching Energy vs Forward Current Diode-inverter

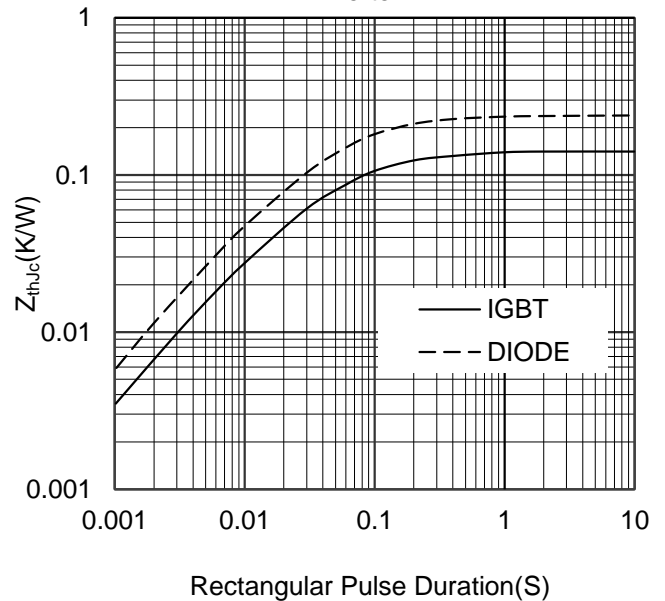

Figure 12. Transient Thermal Impedance of Diode and IGBT-inverter

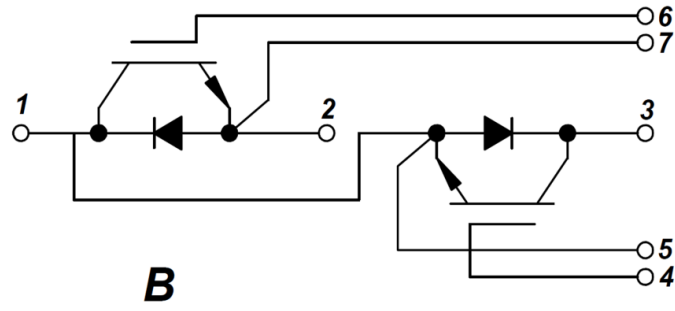

Figure 13. Circuit Diagram

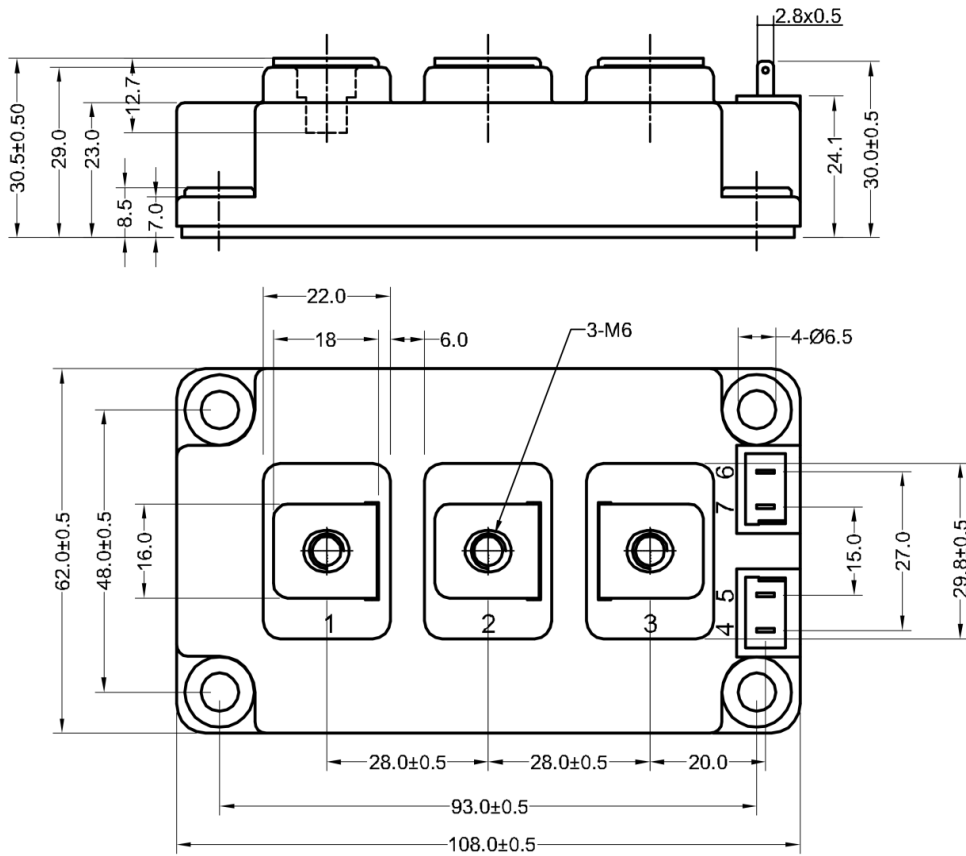

Figure 14. Package Outline