

PRODUCT FEATURES

- IGBT chip in trench FS-technology
- Low switching losses
- $V_{CE(sat)}$ with positive temperature coefficient
- Fast switching and short tail current
- Free wheeling diodes with fast and soft reverse recovery

APPLICATIONS

- Welding Machine
- Power Supplies
- Others



IGBT-inverter

ABSOLUTE MAXIMUM RATINGS ($T_C=25^\circ\text{C}$ unless otherwise specified)

Symbol	Parameter/Test Conditions		Values	Unit
V_{CES}	Collector Emitter Voltage	$T_J=25^\circ\text{C}$	1200	V
V_{GES}	Gate Emitter Voltage		± 20	
I_C	DC Collector Current	$T_C=25^\circ\text{C}, T_{Jmax}=175^\circ\text{C}$	110	A
		$T_C=90^\circ\text{C}, T_{Jmax}=175^\circ\text{C}$	75	
I_{CM}	Repetitive Peak Collector Current	$t_p=1\text{ms}$	150	
P_{tot}	Power Dissipation Per IGBT	$T_C=25^\circ\text{C}, T_{Jmax}=175^\circ\text{C}$	405	W

Diode-inverter

ABSOLUTE MAXIMUM RATINGS ($T_C=25^\circ\text{C}$ unless otherwise specified)

Symbol	Parameter/Test Conditions		Values	Unit
V_{RRM}	Repetitive Reverse Voltage	$T_J=25^\circ\text{C}$	1200	V
$I_{F(AV)}$	Average Forward Current		75	A
I_{FRM}	Repetitive Peak Forward Current	$t_p=1\text{ms}$	150	
I^2t		$T_J=125^\circ\text{C}, t=10\text{ms}, V_R=0\text{V}$	1150	A^2S

MacMic Science & Technology Co., Ltd.

Add: #18, Hua Shan Zhong Lu, New District, Changzhou City, Jiangsu Province, P. R. of China

MMG75S120B6UC

IGBT-inverter

ELECTRICAL CHARACTERISTICS ($T_C=25^\circ\text{C}$ unless otherwise specified)

Symbol	Parameter/Test Conditions		Min.	Typ.	Max.	Unit	
$V_{GE(th)}$	Gate Emitter Threshold Voltage	$V_{CE}=V_{GE}, I_C=3\text{mA}$	5.2	6.0	6.5	V	
$V_{CE(sat)}$	Collector Emitter Saturation Voltage	$I_C=75\text{A}, V_{GE}=15\text{V}, T_J=25^\circ\text{C}$		2.2	2.65		
		$I_C=75\text{A}, V_{GE}=15\text{V}, T_J=125^\circ\text{C}$		2.5			
		$I_C=75\text{A}, V_{GE}=15\text{V}, T_J=150^\circ\text{C}$		2.6			
I_{CES}	Collector Leakage Current	$V_{CE}=1200\text{V}, V_{GE}=0\text{V}, T_J=25^\circ\text{C}$			100	μA	
		$V_{CE}=1200\text{V}, V_{GE}=0\text{V}, T_J=150^\circ\text{C}$			1	mA	
I_{GES}	Gate Leakage Current	$V_{CE}=0\text{V}, V_{GE}=\pm 20\text{V}, T_J=25^\circ\text{C}$	-400		400	nA	
R_{gint}	Integrated Gate Resistor			10		Ω	
Q_g	Gate Charge	$V_{CE}=600\text{V}, I_C=75\text{A}, V_{GE}=15\text{V}$		0.36		μC	
C_{ies}	Input Capacitance	$V_{CE}=25\text{V}, V_{GE}=0\text{V}, f=1\text{MHz}$		5.6		nF	
C_{res}	Reverse Transfer Capacitance				230		pF
$t_{d(on)}$	Turn on Delay Time	$V_{CC}=600\text{V}, I_C=75\text{A}$ $R_G=7.5\Omega,$ $V_{GE}=\pm 15\text{V},$ Inductive Load	$T_J=25^\circ\text{C}$		150	ns	
			$T_J=125^\circ\text{C}$		160	ns	
			$T_J=150^\circ\text{C}$		170	ns	
t_r	Rise Time		$T_J=25^\circ\text{C}$		100	ns	
			$T_J=125^\circ\text{C}$		105	ns	
			$T_J=150^\circ\text{C}$		105	ns	
$t_{d(off)}$	Turn off Delay Time	$T_J=25^\circ\text{C}$		300	ns		
		$T_J=125^\circ\text{C}$		350	ns		
		$T_J=150^\circ\text{C}$		370	ns		
t_f	Fall Time	$T_J=25^\circ\text{C}$		60	ns		
		$T_J=125^\circ\text{C}$		80	ns		
		$T_J=150^\circ\text{C}$		90	ns		
E_{on}	Turn on Energy	$V_{CC}=600\text{V}, I_C=75\text{A}$ $R_G=7.5\Omega,$ $V_{GE}=\pm 15\text{V},$ Inductive Load	$T_J=125^\circ\text{C}$		15.5	mJ	
			$T_J=150^\circ\text{C}$		17	mJ	
E_{off}	Turn off Energy		$T_J=125^\circ\text{C}$		4	mJ	
			$T_J=150^\circ\text{C}$		4.4	mJ	
I_{SC}	Short Circuit Current		$t_{psc} \leq 10\mu\text{s}, V_{GE}=15\text{V}$ $T_J=150^\circ\text{C}, V_{CC}=600\text{V}$		360		A
R_{thJC}	Junction to Case Thermal Resistance (Per IGBT)				0.37	K/W	

Diode-inverter

ELECTRICAL CHARACTERISTICS ($T_C=25^\circ\text{C}$ unless otherwise specified)

Symbol	Parameter/Test Conditions		Min.	Typ.	Max.	Unit
V_F	Forward Voltage	$I_F=75\text{A}, V_{GE}=0\text{V}, T_J=25^\circ\text{C}$		1.65	2.15	V
		$I_F=75\text{A}, V_{GE}=0\text{V}, T_J=125^\circ\text{C}$		1.65		
		$I_F=75\text{A}, V_{GE}=0\text{V}, T_J=150^\circ\text{C}$		1.65		
t_{rr}	Reverse Recovery Time	$I_F=75\text{A}, V_R=600\text{V}$ $dI_F/dt=-1100\text{A}/\mu\text{s}$ $T_J=150^\circ\text{C}$		610		ns
I_{RRM}	Max. Reverse Recovery Current			44		A
Q_{RR}	Reverse Recovery Charge			15		μC
E_{rec}	Reverse Recovery Energy			5.4		mJ
R_{thJCD}	Junction to Case Thermal Resistance (Per Diode)				0.6	K/W

MMG75S120B6UC

MODULE CHARACTERISTICS ($T_C=25^\circ\text{C}$ unless otherwise specified)

Symbol	Parameter/Test Conditions	Values	Unit	
T_{Jmax}	Max. Junction Temperature	175	$^\circ\text{C}$	
T_{Jop}	Operating Temperature	-40~150		
T_{stg}	Storage Temperature	-40~125		
V_{isol}	Isolation Breakdown Voltage	AC, 50Hz(R.M.S), $t=1$ minute	3000	V
CTI	Comparative Tracking Index		> 200	
Torque	to heatsink	Recommended (M6)	3~5	Nm
	to terminal	Recommended (M5)	2.5~5	Nm
Weight			160	g

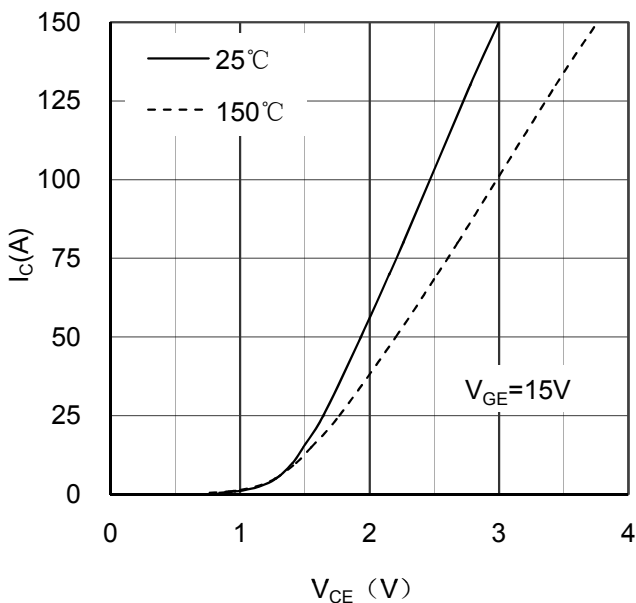

Figure 1. Typical Output Characteristics IGBT-inverter

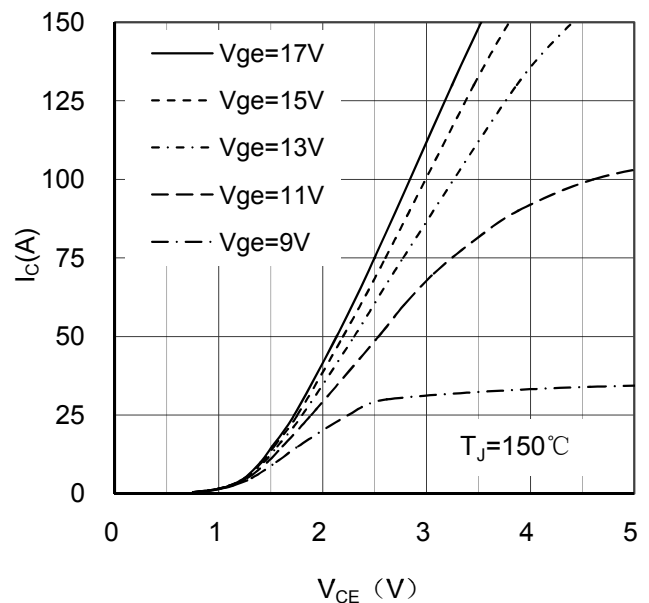

Figure 2. Typical Output Characteristics IGBT-inverter

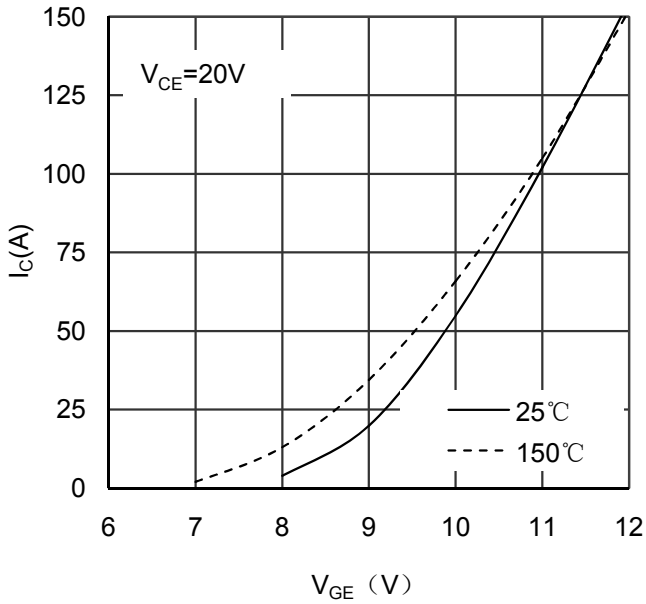

Figure 3. Typical Transfer characteristics IGBT-inverter

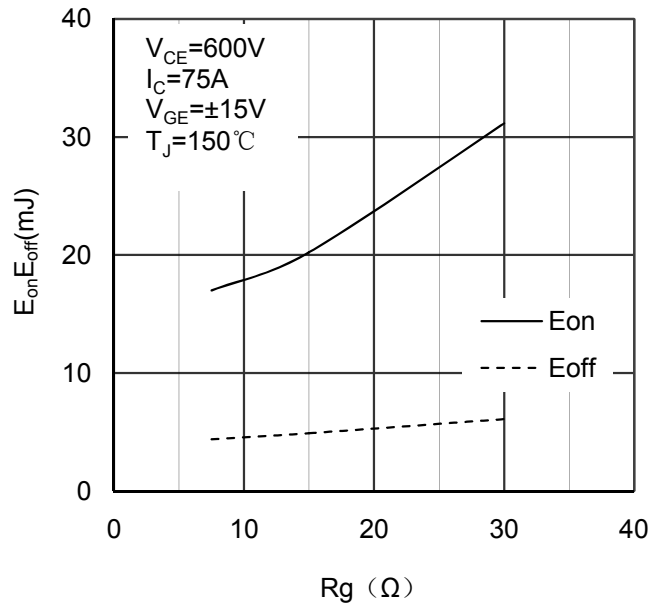

Figure 4. Switching Energy vs Gate Resistor IGBT-inverter

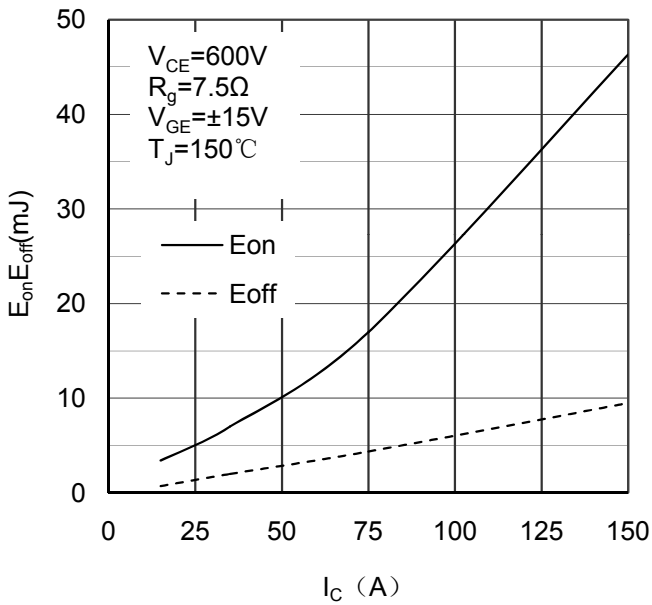

Figure 5. Switching Energy vs Collector Current IGBT-inverter

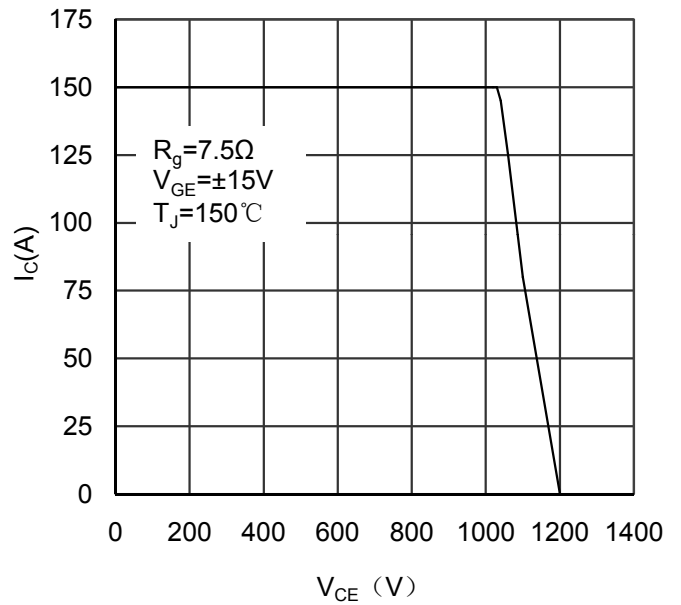

Figure 6. Reverse Biased Safe Operating Area IGBT-inverter

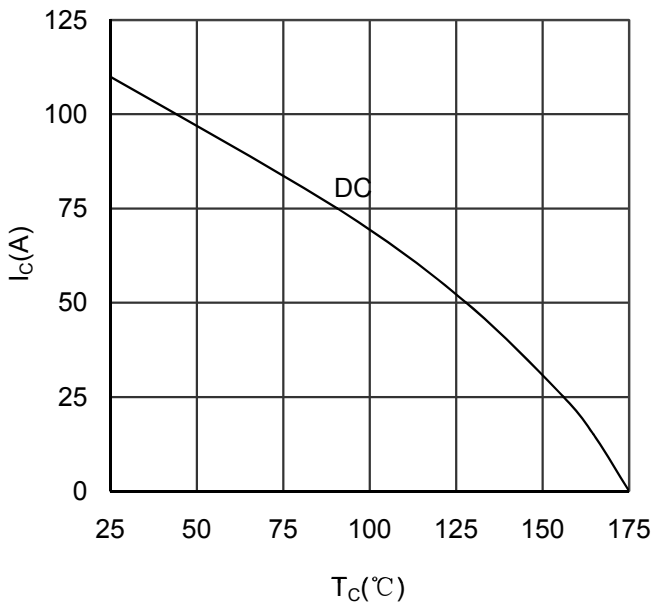

Figure 7. Collector Current vs Case temperature IGBT -inverter

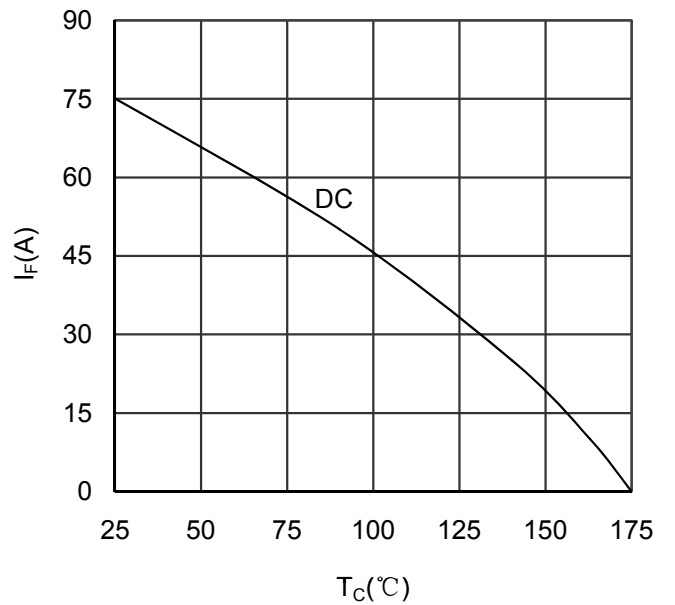

Figure 8. Forward current vs Case temperature Diode -inverter

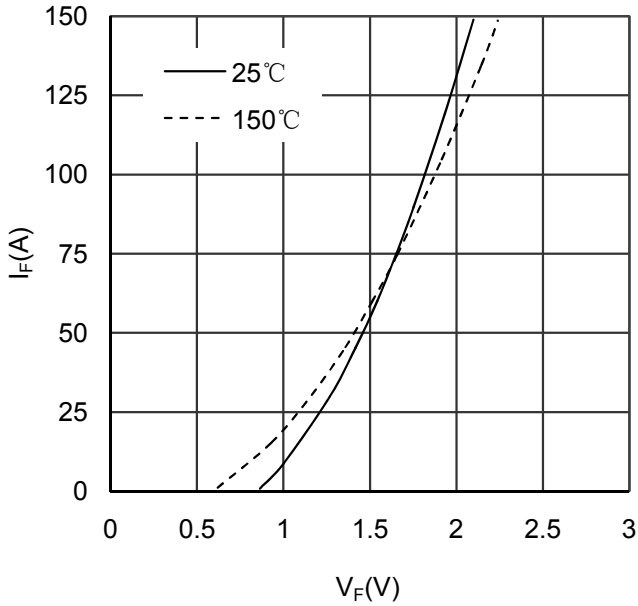

Figure 9. Diode Forward Characteristics Diode -inverter

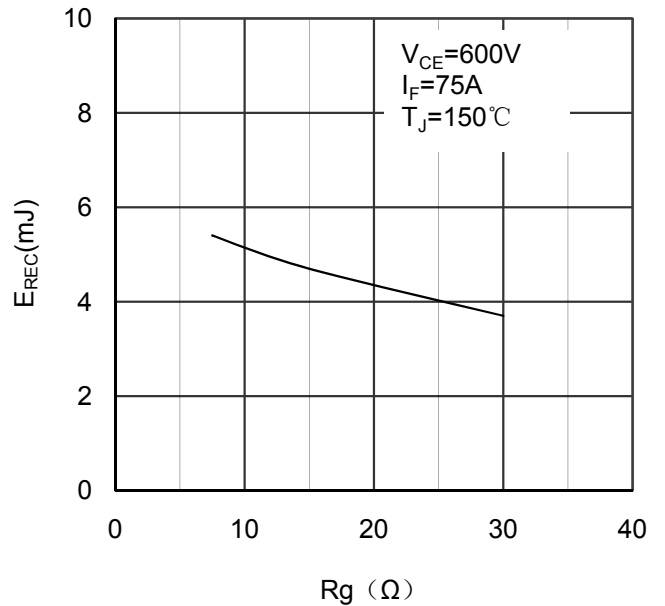

Figure 10. Switching Energy vs Gate Resistor Diode -inverter

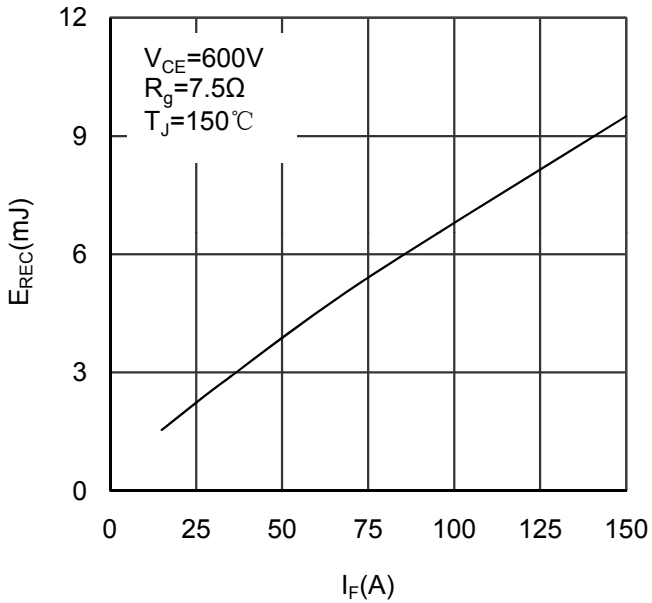

Figure 11. Switching Energy vs Forward Current Diode-inverter

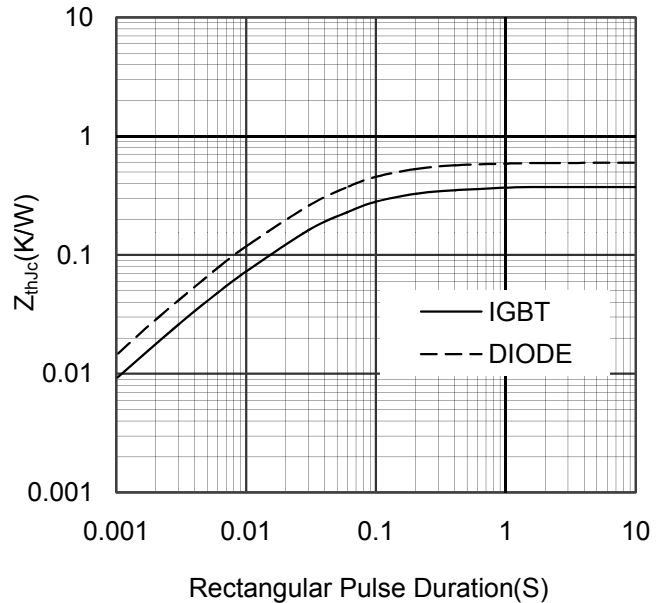

Figure 12. Transient Thermal Impedance of Diode and IGBT-inverter

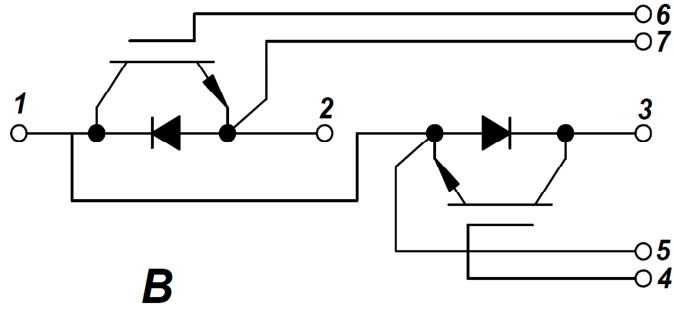
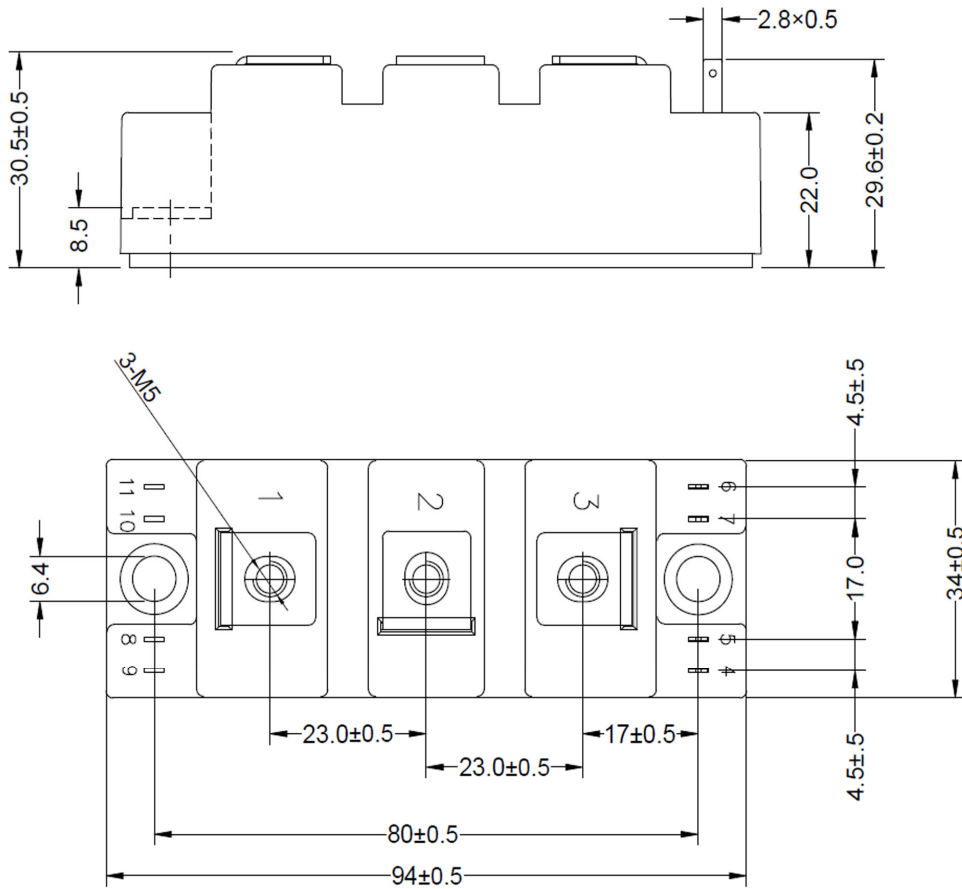

Figure 13. Circuit Diagram



Dimensions in (mm)
Figure 14. Package Outline