

## PRODUCT FEATURES

- High level of integration
- IGBT CHIP(Trench+Field Stop technology)
- Low saturation voltage and positive temperature coefficient
- Fast switching and short tail current
- Free wheeling diodes with fast and soft reverse recovery
- Industry standard package with insulated copper base plate and soldering pins for PCB mounting
- Temperature sense included

## APPLICATIONS

- AC motor control
- Motion/servo control
- Inverter and power supplies

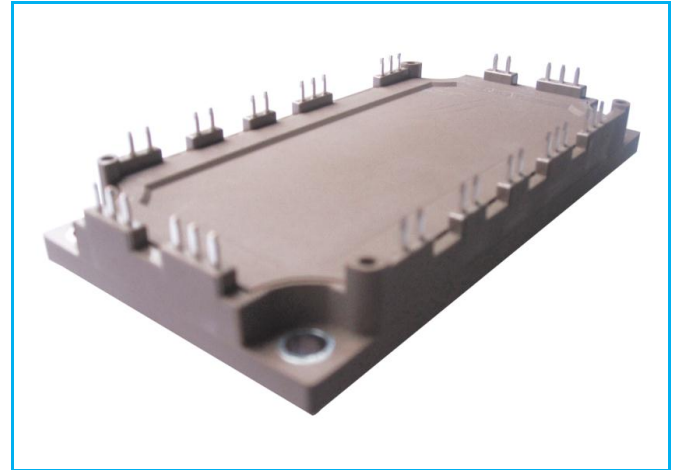

Rectifier+Brake+Inverter

### IGBT-inverter

ABSOLUTE MAXIMUM RATINGS( $T_C=25^{\circ}\text{C}$  unless otherwise specified)

Symbol	Parameter/Test Conditions		Values	Unit
$V_{CES}$	Collector Emitter Voltage	$T_J=25^{\circ}\text{C}$	1200	V
$V_{GES}$	Gate Emitter Voltage		$\pm 20$	
$I_C$	DC Collector Current	$T_C=25^{\circ}\text{C}, T_{Jmax}=175^{\circ}\text{C}$	110	A
		$T_C=95^{\circ}\text{C}, T_{Jmax}=175^{\circ}\text{C}$	75	
$I_{CM}$	Repetitive Peak Collector Current	$tp=1\text{ms}$	150	
$P_{tot}$	Power Dissipation Per IGBT	$T_C=25^{\circ}\text{C}, T_{Jmax}=175^{\circ}\text{C}$	375	W

### Diode-inverter

ABSOLUTE MAXIMUM RATINGS ( $T_C=25^{\circ}\text{C}$  unless otherwise specified)

Symbol	Parameter/Test Conditions		Values	Unit
$V_{RRM}$	Repetitive Reverse Voltage	$T_J=25^{\circ}\text{C}$	1200	V
$I_{F(AV)}$	Average Forward Current		75	A
$I_{FRM}$	Repetitive Peak Forward Current	$tp=1\text{ms}$	150	
$I^2t$		$T_J=125^{\circ}\text{C}, t=10\text{ms}, V_R=0\text{V}$	1250	$\text{A}^2\text{s}$

MacMic Science & Technology Co., Ltd.

Add: #18, Hua Shan Zhong Lu, New District, Changzhou City, Jiangsu Province, P. R. of China

Tel.: +86-519-85163708 Fax: +86-519-85162291 Post Code: 213022 Website: www.macmicst.com

## MMG75WD120XB6TC

### IGBT-inverter

#### ELECTRICAL CHARACTERISTICS ( $T_C=25^\circ\text{C}$ unless otherwise specified)

Symbol	Parameter/Test Conditions		Min.	Typ.	Max.	Unit	
$V_{GE(th)}$	Gate Emitter Threshold Voltage	$V_{CE}=V_{GE}, I_C=3\text{mA}$	5.0	5.8	6.5	V	
$V_{CE(sat)}$	Collector - Emitter Saturation Voltage	$I_C=75\text{A}, V_{GE}=15\text{V}, T_J=25^\circ\text{C}$		1.8	2.25		
		$I_C=75\text{A}, V_{GE}=15\text{V}, T_J=125^\circ\text{C}$		2.1			
		$I_C=75\text{A}, V_{GE}=15\text{V}, T_J=150^\circ\text{C}$		2.15			
$I_{CES}$	Collector Leakage Current	$V_{CE}=1200\text{V}, V_{GE}=0\text{V}, T_J=25^\circ\text{C}$			1	mA	
		$V_{CE}=1200\text{V}, V_{GE}=0\text{V}, T_J=150^\circ\text{C}$			10		
$I_{GES}$	Gate Leakage Current	$V_{CE}=0\text{V}, V_{GE}=\pm 20\text{V}, T_J=25^\circ\text{C}$	-400		400	nA	
$R_{Gint}$	Integrated Gate Resistor			5		$\Omega$	
$Q_G$	Gate Charge	$V_{CE}=600\text{V}, I_C=75\text{A}, V_{GE}=15\text{V}$		0.4		$\mu\text{C}$	
$C_{ies}$	Input Capacitance	$V_{CE}=25\text{V}, V_{GE}=0\text{V}, f=1\text{MHz}$		8		nF	
$C_{res}$	Reverse Transfer Capacitance				220		pF
$t_{d(on)}$	Turn on Delay Time	$V_{CC}=600\text{V}, I_C=75\text{A}$ $R_G=3.6\Omega,$ $V_{GE}=\pm 15\text{V},$ Inductive Load	$T_J=25^\circ\text{C}$	40		ns	
			$T_J=125^\circ\text{C}$	45		ns	
			$T_J=150^\circ\text{C}$	50		ns	
$t_r$	Rise Time		$T_J=25^\circ\text{C}$	25		ns	
			$T_J=125^\circ\text{C}$	30		ns	
			$T_J=150^\circ\text{C}$	30		ns	
$t_{d(off)}$	Turn off Delay Time	$T_J=25^\circ\text{C}$	290		ns		
		$T_J=125^\circ\text{C}$	330		ns		
		$T_J=150^\circ\text{C}$	350		ns		
$t_f$	Fall Time	$T_J=25^\circ\text{C}$	140		ns		
		$T_J=125^\circ\text{C}$	210		ns		
		$T_J=150^\circ\text{C}$	230		ns		
$E_{on}$	Turn on Energy	$V_{CC}=600\text{V}, I_C=75\text{A}$ $R_G=3.6\Omega,$ $V_{GE}=\pm 15\text{V},$ Inductive Load	$T_J=125^\circ\text{C}$	6.5		mJ	
			$T_J=150^\circ\text{C}$	7.2		mJ	
$E_{off}$	Turn off Energy		$T_J=125^\circ\text{C}$	5.4		mJ	
			$T_J=150^\circ\text{C}$	5.9		mJ	
$I_{SC}$	Short Circuit Current		$tpsc \leq 10\mu\text{s}, V_{GE}=15\text{V}$ $T_J=150^\circ\text{C}, V_{CC}=800\text{V}$		280		A
$R_{thJC}$	Junction to Case Thermal Resistance (Per IGBT)				0.4	K/W	

### Diode-inverter

#### ELECTRICAL CHARACTERISTICS ( $T_C=25^\circ\text{C}$ unless otherwise specified)

Symbol	Parameter/Test Conditions		Min.	Typ.	Max.	Unit
$V_F$	Forward Voltage	$I_F=75\text{A}, V_{GE}=0\text{V}, T_J=25^\circ\text{C}$		1.75	2.15	V
		$I_F=75\text{A}, V_{GE}=0\text{V}, T_J=125^\circ\text{C}$		1.55		
		$I_F=75\text{A}, V_{GE}=0\text{V}, T_J=150^\circ\text{C}$		1.50		
$t_{rr}$	Reverse Recovery Time	$I_F=75\text{A}, V_R=600\text{V}$ $dI_F/dt=-2100\text{A}/\mu\text{s}$ $T_J=150^\circ\text{C}$		280		ns
$I_{RRM}$	Max. Reverse Recovery Current			110		A
$Q_{RR}$	Reverse Recovery Charge			19.8		$\mu\text{C}$
$E_{rec}$	Reverse Recovery Energy			7.1		mJ
$R_{thJCD}$	Junction to Case Thermal Resistance (Per Diode)				0.58	K/W

## MMG75WD120XB6TC

### Diode-RECTIFIER

ABSOLUTE MAXIMUM RATINGS ( $T_C=25^\circ\text{C}$  unless otherwise specified)

Symbol	Parameter/Test Conditions		Values	Unit
$V_{RRM}$	Repetitive Reverse Voltage	$T_J=25^\circ\text{C}$	2000	V
$I_{F(AV)}$	Average Forward Current Per Diode	$T_C=80^\circ\text{C}$	70	A
$I_{FRMS}$	R.M.S. Forward Current Per Diode		125	
$I_{RMS}$	R.M.S. Current at rectifier output		150	
$I_{FSM}$	Non Repetitive Surge Forward Current	$T_J=45^\circ\text{C}$ , $t=10\text{ms}$ , 50Hz	1200	A
		$T_J=45^\circ\text{C}$ , $t=8.3\text{ms}$ , 60Hz	1340	
$I^2t$		$T_J=45^\circ\text{C}$ , $t=10\text{ms}$ , 50Hz	7200	$\text{A}^2\text{s}$
		$T_J=45^\circ\text{C}$ , $t=8.3\text{ms}$ , 60Hz	7200	

### Diode-RECTIFIER

ELECTRICAL CHARACTERISTICS ( $T_C=25^\circ\text{C}$  unless otherwise specified)

Symbol	Parameter/Test Conditions	Min.	Typ.	Max.	Unit	
$V_F$	Forward Voltage	$I_F=75\text{A}$ , $T_J=25^\circ\text{C}$		1.05	1.25	V
		$I_F=75\text{A}$ , $T_J=150^\circ\text{C}$		0.98		V
$I_R$	Reverse Leakage Current	$V_R=1600\text{V}$ , $T_J=25^\circ\text{C}$			50	$\mu\text{A}$
		$V_R=1600\text{V}$ , $T_J=150^\circ\text{C}$			1	mA
$R_{thJCD}$	Junction to Case Thermal Resistance ( Per Diode)			0.46	K /W	

### IGBT-Brake chopper

ABSOLUTE MAXIMUM RATINGS ( $T_C=25^\circ\text{C}$  unless otherwise specified)

Symbol	Parameter/Test Conditions		Values	Unit
$V_{CES}$	Collector Emitter Voltage	$T_J=25^\circ\text{C}$	1200	V
$V_{GES}$	Gate Emitter Voltage		$\pm 20$	
$I_C$	DC Collector Current	$T_C=25^\circ\text{C}$ , $T_{Jmax}=175^\circ\text{C}$	76	A
		$T_C=100^\circ\text{C}$ , $T_{Jmax}=175^\circ\text{C}$	50	
$I_{CM}$	Repetitive Peak Collector Current	$t_p=1\text{ms}$	100	
$P_{tot}$	Power Dissipation Per IGBT	$T_C=25^\circ\text{C}$ , $T_{Jmax}=175^\circ\text{C}$	278	W

### Diode-Brake chopper

ABSOLUTE MAXIMUM RATINGS ( $T_C=25^\circ\text{C}$  unless otherwise specified)

Symbol	Parameter/Test Conditions		Values	Unit
$V_{RRM}$	Repetitive Reverse Voltage	$T_J=25^\circ\text{C}$	1200	V
$I_{F(AV)}$	Average Forward Current		35	A
$I_{FRM}$	Repetitive Peak Forward Current	$t_p=1\text{ms}$	70	
$I^2t$		$T_J=125^\circ\text{C}$ , $t=10\text{ms}$ , $V_R=0\text{V}$	270	$\text{A}^2\text{s}$

## MMG75WD120XB6TC

IGBT-Brake chopper

ELECTRICAL CHARACTERISTICS ( $T_C=25^\circ\text{C}$  unless otherwise specified)

Symbol	Parameter/Test Conditions		Min.	Typ.	Max.	Unit	
$V_{GE(th)}$	Gate Emitter Threshold Voltage	$V_{CE}=V_{GE}, I_C=2\text{mA}$	5.0	5.8	6.5	V	
$V_{CE(sat)}$	Collector Emitter Saturation Voltage	$I_C=50\text{A}, V_{GE}=15\text{V}, T_J=25^\circ\text{C}$		1.8	2.25		
		$I_C=50\text{A}, V_{GE}=15\text{V}, T_J=125^\circ\text{C}$		2.1			
		$I_C=50\text{A}, V_{GE}=15\text{V}, T_J=150^\circ\text{C}$		2.15			
$I_{CES}$	Collector Leakage Current	$V_{CE}=1200\text{V}, V_{GE}=0\text{V}, T_J=25^\circ\text{C}$			1	mA	
		$V_{CE}=1200\text{V}, V_{GE}=0\text{V}, T_J=150^\circ\text{C}$			10		
$I_{GES}$	Gate Leakage Current	$V_{CE}=0\text{V}, V_{GE}=\pm 20\text{V}, T_J=25^\circ\text{C}$	-400		400	nA	
$R_{Gint}$	Integrated Gate Resistor			4		$\Omega$	
$Q_G$	Gate Charge	$V_{CE}=600\text{V}, I_C=50\text{A}, V_{GE}=15\text{V}$		0.28		$\mu\text{C}$	
$C_{ies}$	Input Capacitance	$V_{CE}=25\text{V}, V_{GE}=0\text{V}, f=1\text{MHz}$		5.9		nF	
$C_{res}$	Reverse Transfer Capacitance				137		pF
$t_{d(on)}$	Turn on Delay Time	$V_{CC}=600\text{V}, I_C=50\text{A}$ $R_G=5.1\Omega,$ $V_{GE}=\pm 15\text{V},$ Inductive Load	$T_J=25^\circ\text{C}$	20		ns	
			$T_J=125^\circ\text{C}$	30		ns	
			$T_J=150^\circ\text{C}$	35		ns	
$t_r$	Rise Time		$T_J=25^\circ\text{C}$	24		ns	
			$T_J=125^\circ\text{C}$	28		ns	
			$T_J=150^\circ\text{C}$	28		ns	
$t_{d(off)}$	Turn off Delay Time	$T_J=25^\circ\text{C}$	230		ns		
		$T_J=125^\circ\text{C}$	270		ns		
		$T_J=150^\circ\text{C}$	280		ns		
$t_f$	Fall Time	$T_J=25^\circ\text{C}$	80		ns		
		$T_J=125^\circ\text{C}$	120		ns		
		$T_J=150^\circ\text{C}$	150		ns		
$E_{on}$	Turn on Energy	$V_{CC}=600\text{V}, I_C=50\text{A}$ $R_G=5.1\Omega,$ $V_{GE}=\pm 15\text{V},$ Inductive Load	$T_J=125^\circ\text{C}$	3.8		mJ	
			$T_J=150^\circ\text{C}$	4.3		mJ	
$E_{off}$	Turn off Energy		$T_J=125^\circ\text{C}$	3.2		mJ	
			$T_J=150^\circ\text{C}$	3.5		mJ	
$I_{SC}$	Short Circuit Current		$tpsc \leq 10\mu\text{s}, V_{GE}=15\text{V}$ $T_J=150^\circ\text{C}, V_{CC}=800\text{V}$		220		A
$R_{thJC}$	Junction to Case Thermal Resistance (Per IGBT)				0.54	K/W	

Diode-Brake chopper

ELECTRICAL CHARACTERISTICS ( $T_C=25^\circ\text{C}$  unless otherwise specified)

Symbol	Parameter/Test Conditions		Min.	Typ.	Max.	Unit
$V_F$	Forward Voltage	$I_F=35\text{A}, V_{GE}=0\text{V}, T_J=25^\circ\text{C}$		1.8	2.4	V
		$I_F=35\text{A}, V_{GE}=0\text{V}, T_J=125^\circ\text{C}$		1.55		
		$I_F=35\text{A}, V_{GE}=0\text{V}, T_J=150^\circ\text{C}$		1.5		
$t_{rr}$	Reverse Recovery Time	$I_F=35\text{A}, V_R=600\text{V}$ $dI_F/dt=-2600\text{A}/\mu\text{s}$ $T_J=150^\circ\text{C}$		100		ns
$I_{RRM}$	Max. Reverse Recovery Current			95		A
$Q_{RR}$	Reverse Recovery Charge			7.9		$\mu\text{C}$
$E_{rec}$	Reverse Recovery Energy			3.4		mJ
$R_{thJCD}$	Junction to Case Thermal Resistance (Per Diode)				1.05	K/W

# MMG75WD120XB6TC

## NTC CHARACTERISTICS ( $T_C=25^\circ\text{C}$ unless otherwise specified)

Symbol	Parameter/Test Conditions	Min.	Typ.	Max.	Unit
$R_{25}$	Resistance $T_C = 25^\circ\text{C}$		5		k $\Omega$
$B_{25/50}$	$R_2 = R_{25} \exp [B_{25/50}(1/T_2 - 1/(298.15 \text{ K}))]$		3375		K

## MODULE CHARACTERISTICS ( $T_C=25^\circ\text{C}$ unless otherwise specified)

Symbol	Parameter/Test Conditions	Values	Unit	
$T_{Jmax}$	Max. Junction Temperature	Inverter, Brake-Chopper	175	
		Rectifier	150	
$T_{Jop}$	Operating Temperature	-40~150	°C	
$T_{stg}$	Storage Temperature	-40~125		
$V_{isol}$	Isolation Breakdown Voltage	AC, 50Hz(R.M.S), t=1minute		3000
CTI	Comparative Tracking Index		>200	
Md	Mounting Torque	Recommended (M5)	2.5~5	Nm
Weight			300	g

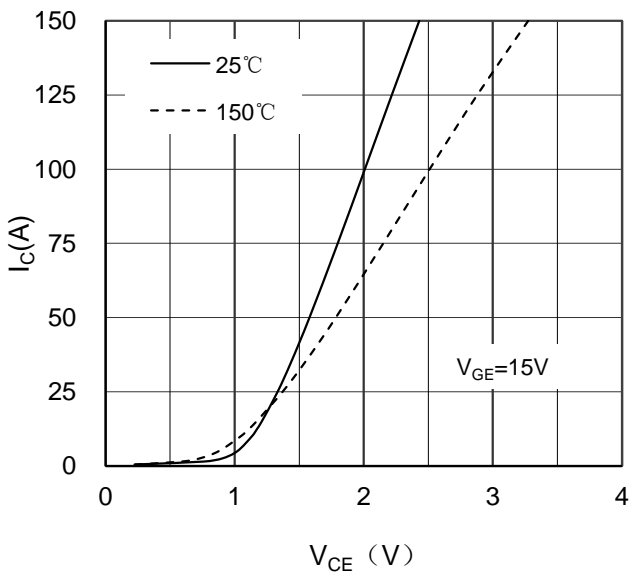

Figure 1. Typical Output Characteristics IGBT-inverter

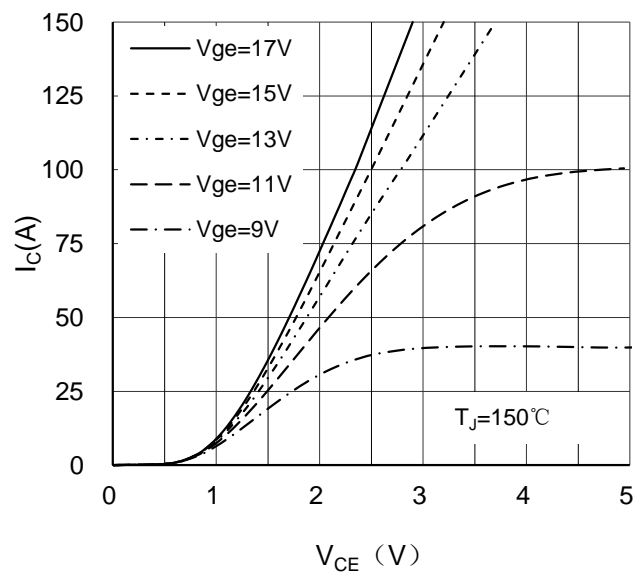

Figure 2. Typical Output Characteristics IGBT-inverter

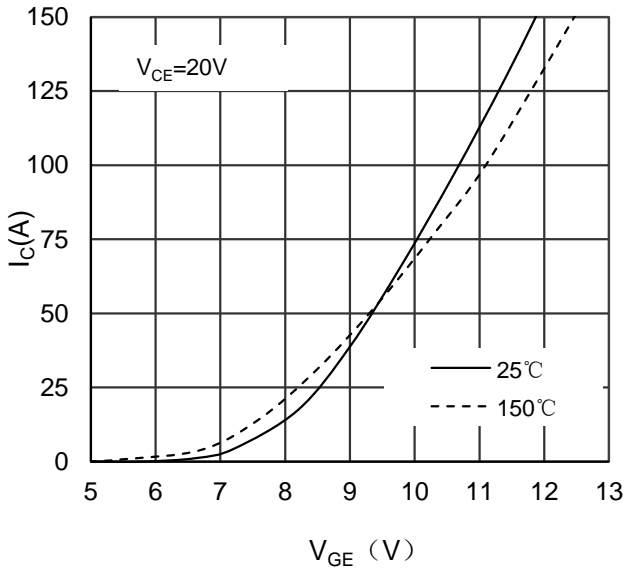

Figure 3. Typical Transfer characteristics IGBT-inverter

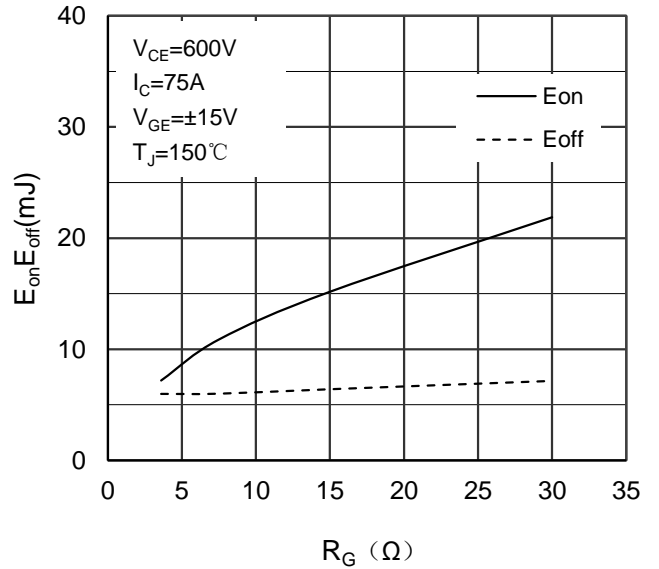

Figure 4. Switching Energy vs Gate Resistor IGBT-inverter

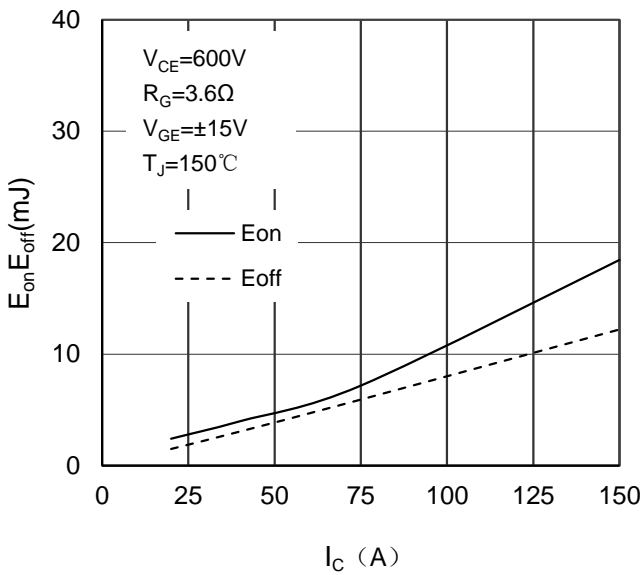

Figure 5. Switching Energy vs Collector Current IGBT-inverter

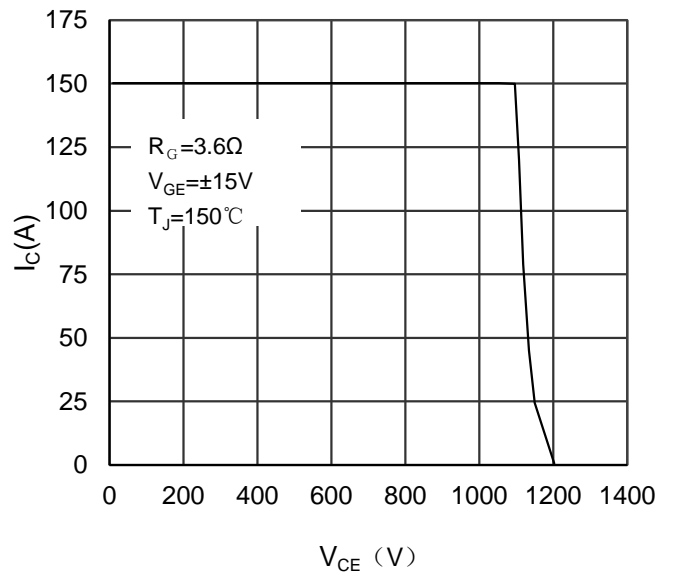

Figure 6. Reverse Biased Safe Operating Area IGBT-inverter

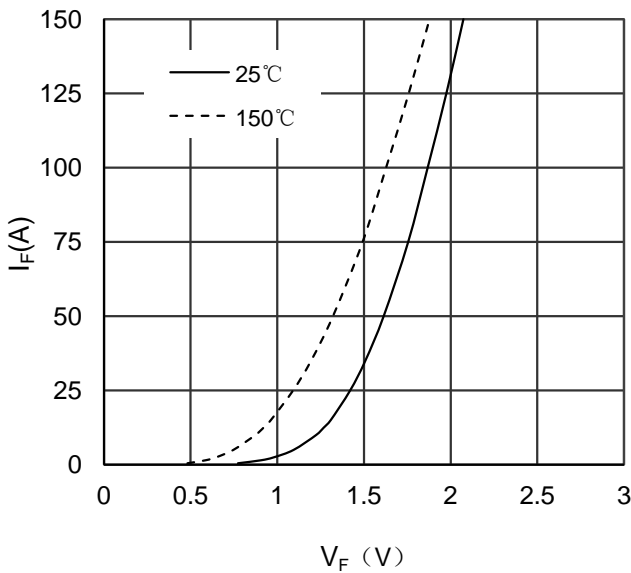

Figure 7. Diode Forward Characteristics Diode -inverter

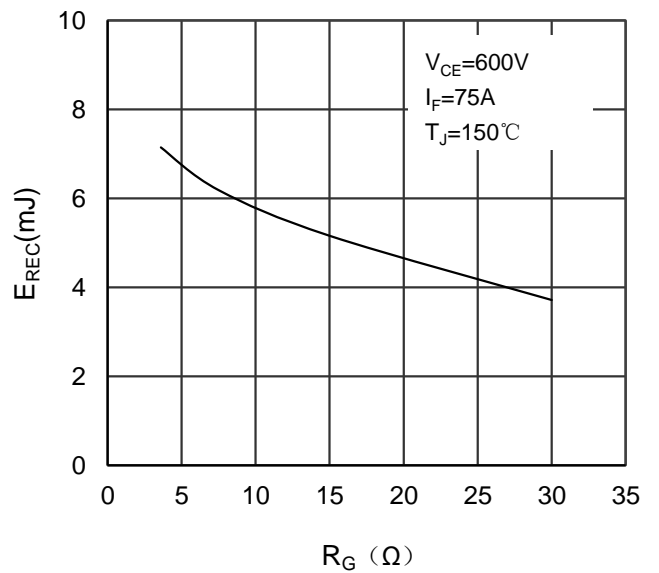

Figure 8. Switching Energy vs Gate Resistor Diode -inverter

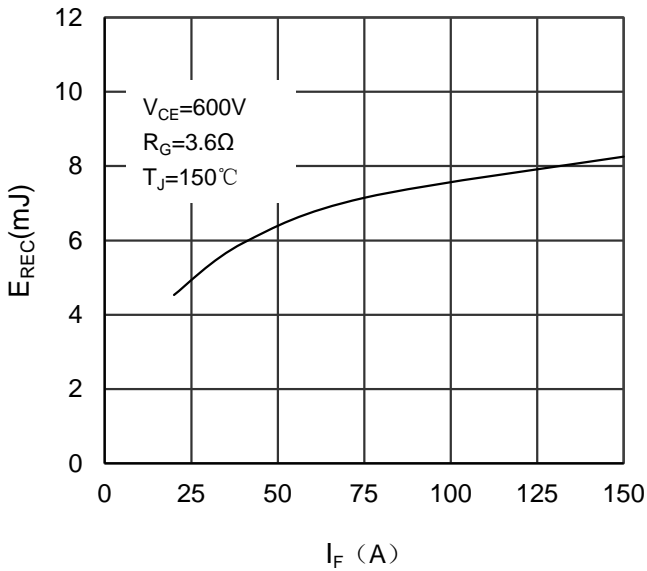

Figure 9. Switching Energy vs Forward Current Diode-inverter

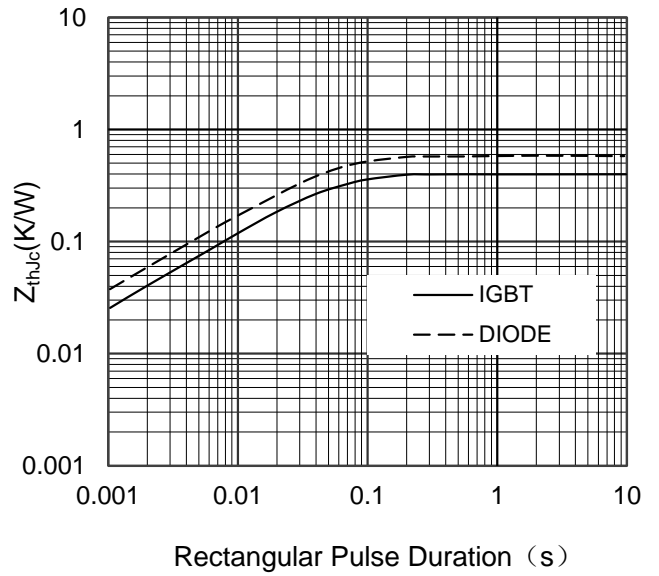

Figure 10. Transient Thermal Impedance of Diode and IGBT-inverter

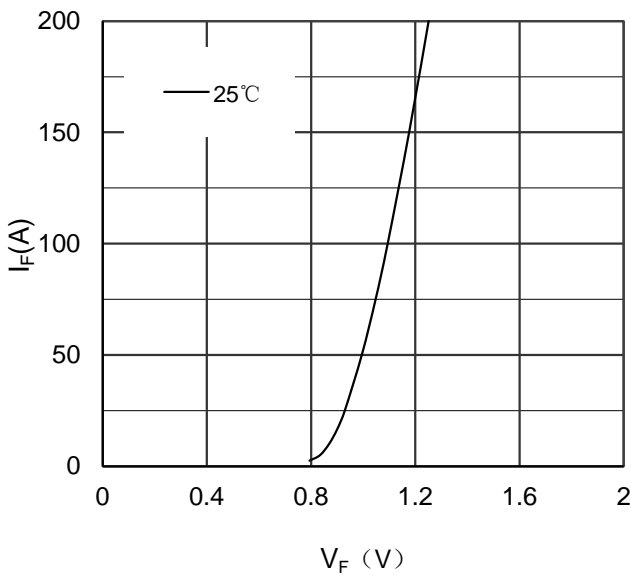

Figure 11. Diode Forward Characteristics Diode-rectifier

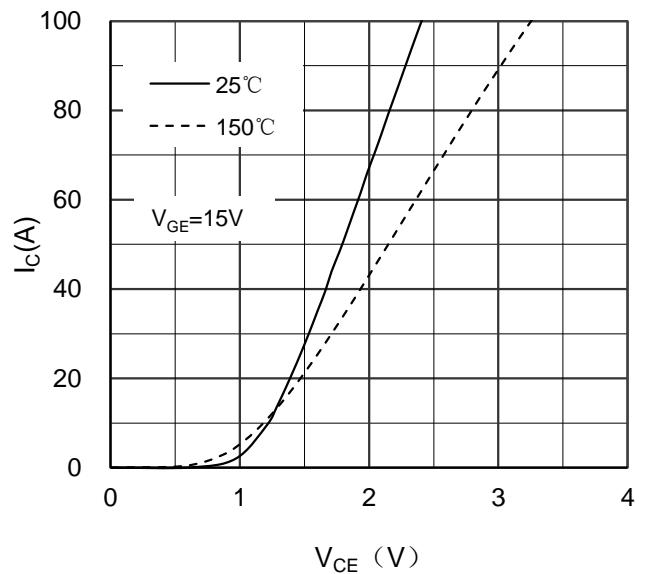

Figure 12. Typical Output Characteristics IGBT-brake chopper

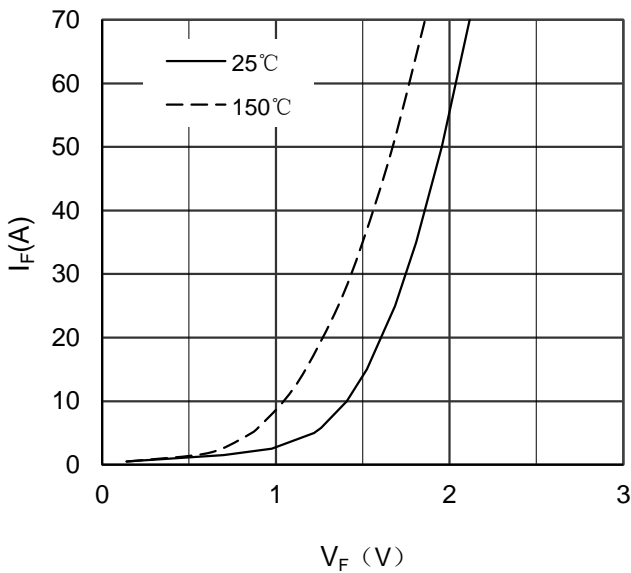

Figure 13. Diode Forward Characteristics Diode-brake chopper

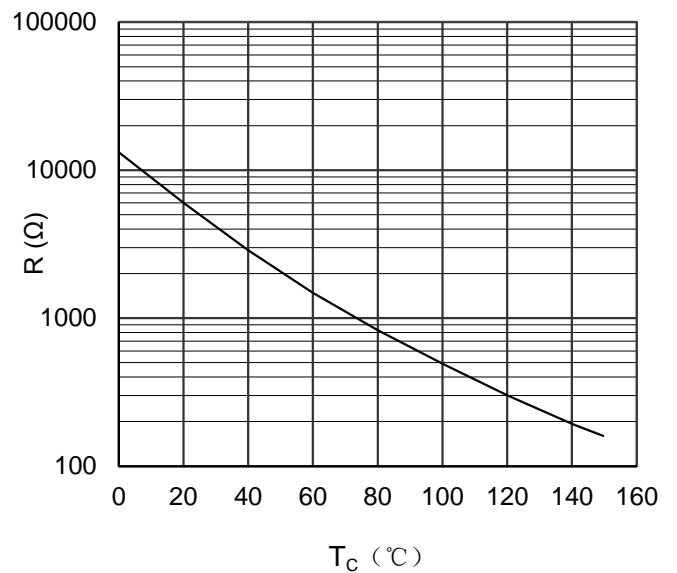

Figure 14. NTC Characteristics

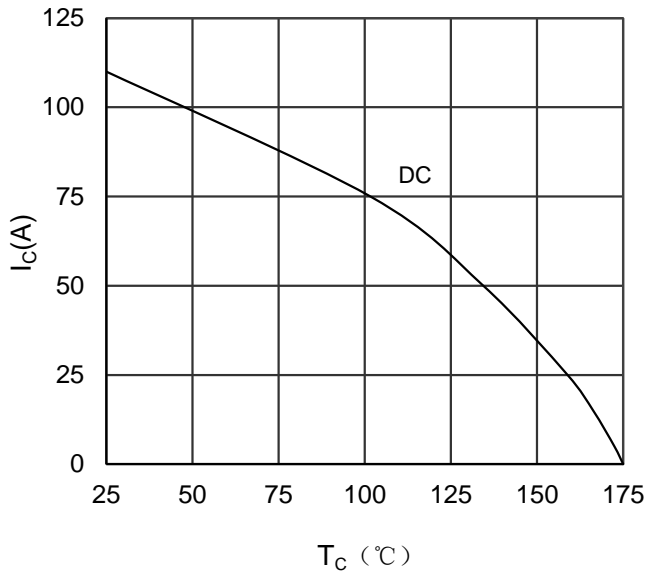

Figure 15. Collector Current vs Case temperature IGBT -inverter

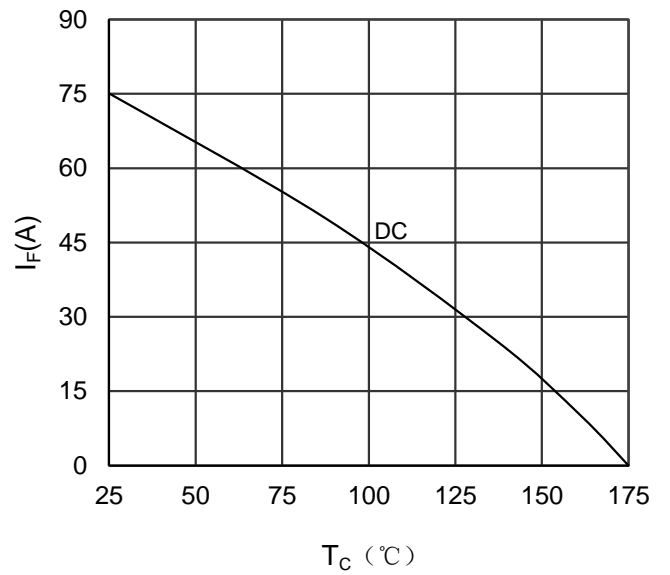

Figure 16. Forward current vs Case temperature Diode -inverter

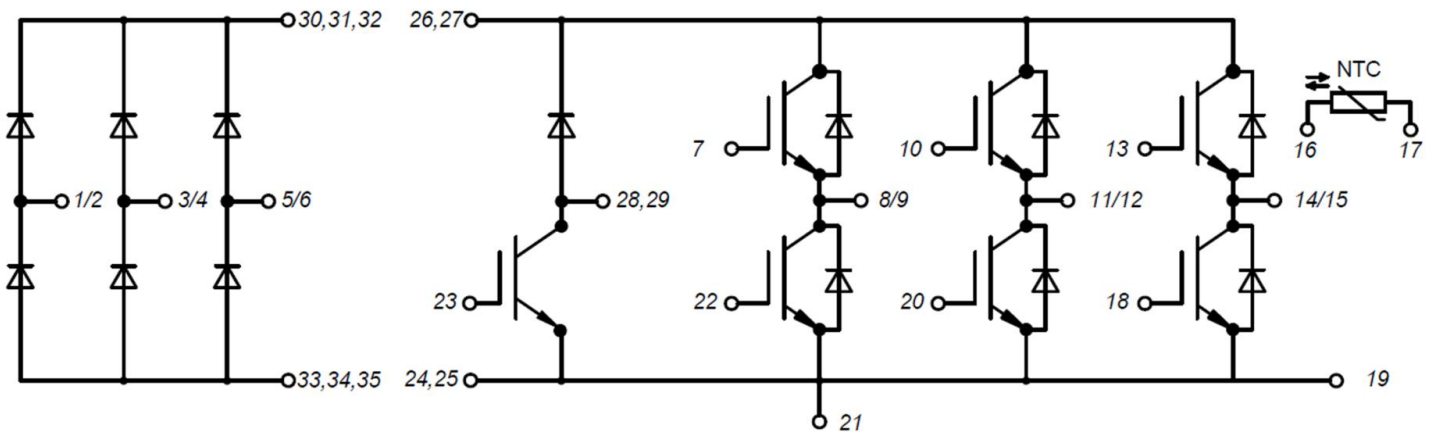
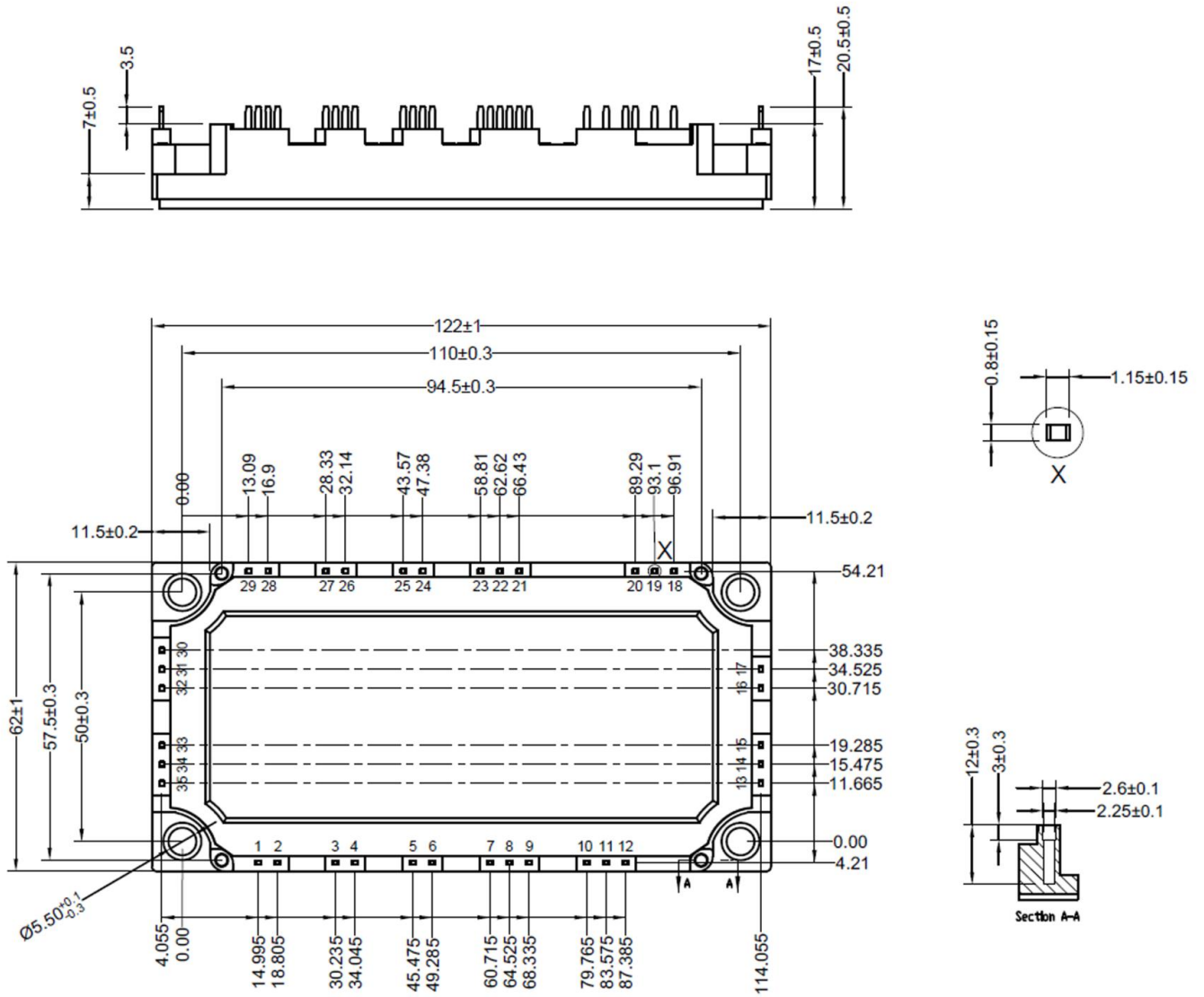

Figure 17. Circuit Diagram





Dimensions in (mm)  
Figure 18. Package Outline